

Application : Tuning in antenna, Impedance matching

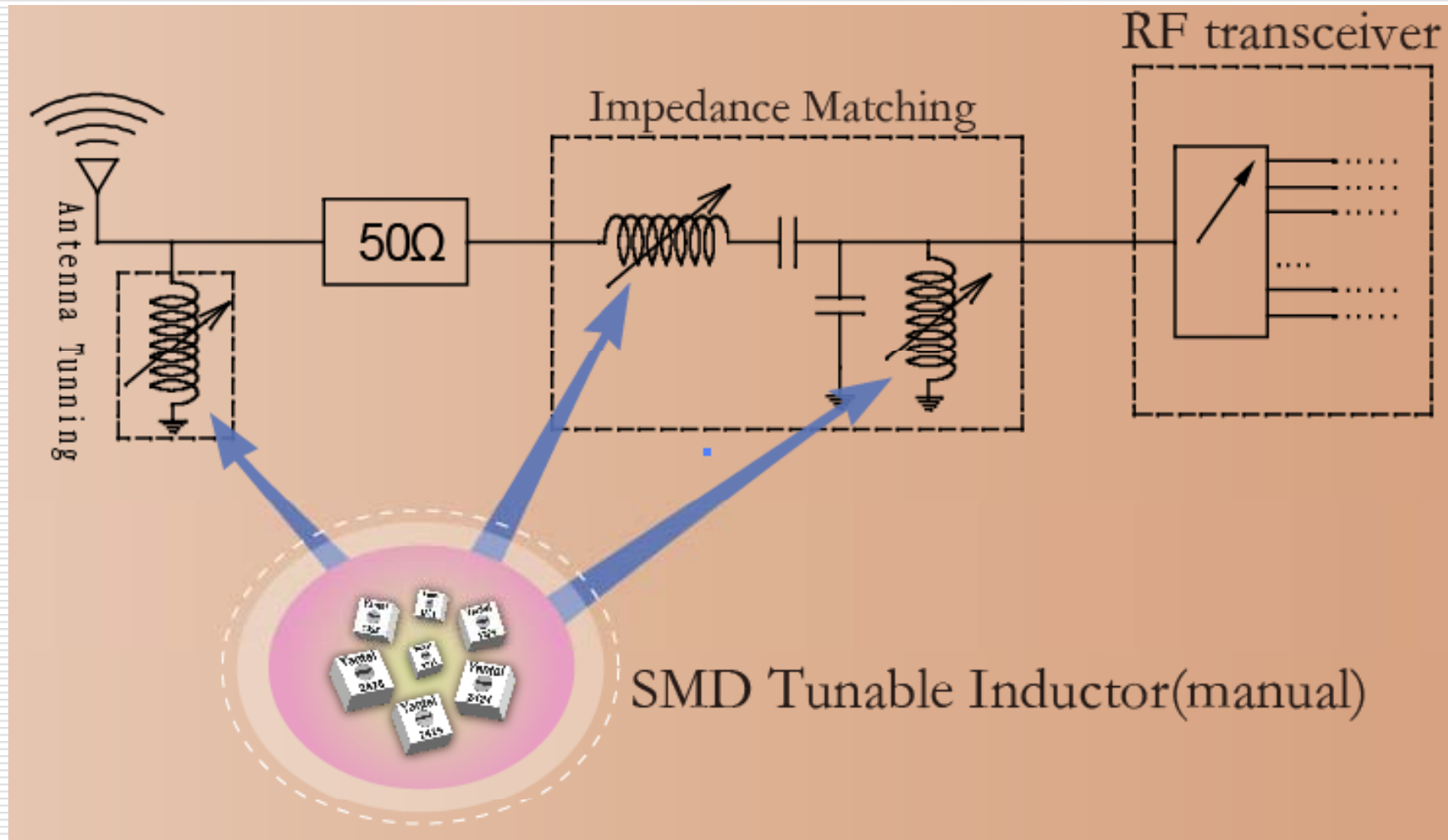

Application : in Filter

- Notch filter

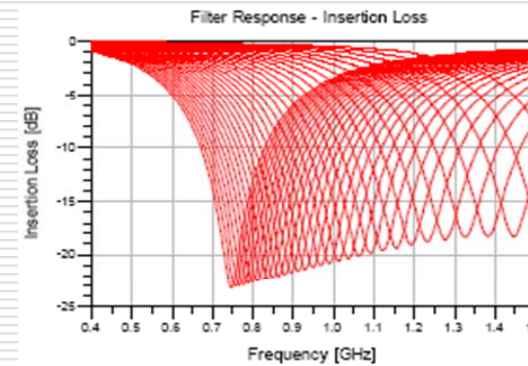
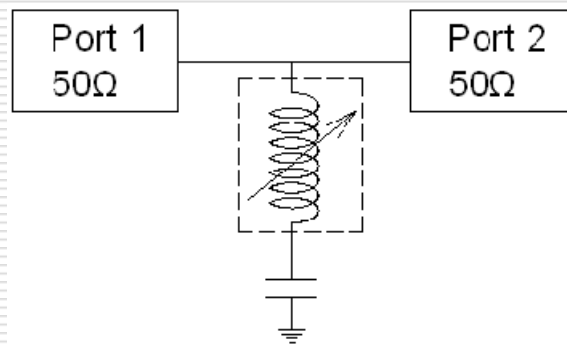

- Band-pass filter

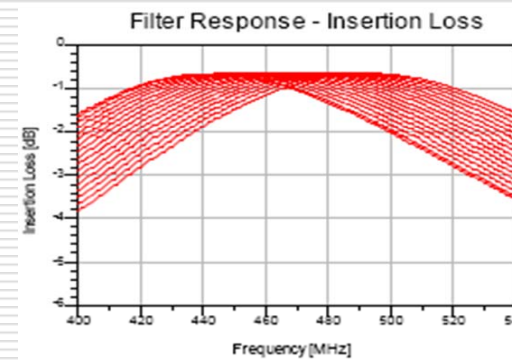
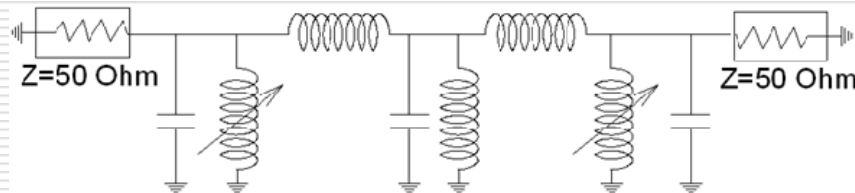

Application : Phase Shifter

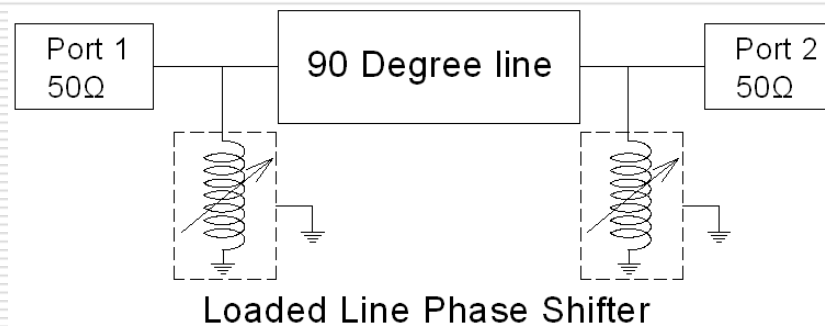
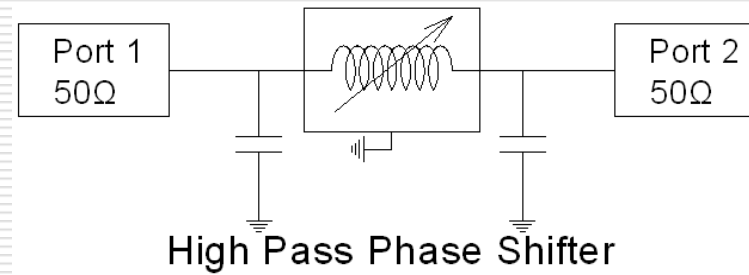
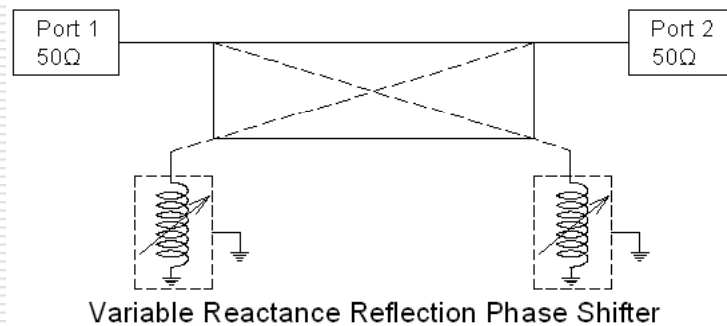

SMD RF Manual Tunable Inductor

Applications

- RF Impedance Matching
- Tunable Antennas
- Tuning Resonant Circuit
- Tunable Filter
- Phase Shifter
- Phased Array Radar
- MRI(Magnetic Resonance Imaging)
- NMR(Nuclear Magnetic Resonance)
- Crystal Oscillator
- Broadband Antenna
- Auto Electronics(Reverse Parking Sensor
high temperature condition)



Antenna



MRI



10 Channels Tunable Filter



Reverse Parking Sensor