

Preliminary Datasheet

QF1400W06B

Quadrifilar Directional Coupler

1165 MHz- 1300 MHz

1520 MHz- 1660 MHz



Rev A1.0

Features

- Ultra Small Size (9.8×7.9mm)
- Excellent phase & amplitude balance
- Excellent repeatability
- Passive RF Component, no need external DC power supply
- Have one Input port and four Output ports that have -6dB -(0°, 90°, 180°, 270°) of phase difference
- Quadrifilar Coupler, 4-Phased Antenna Feeder, Helicaled Antenna Feeder
- Operating Temperature: -40°C to +105°C
- Tape & Reel

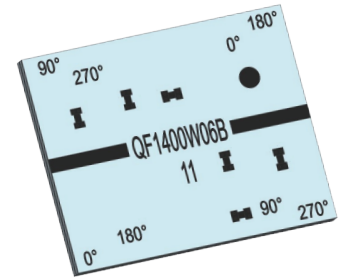

Applications

- Realizing the World's Most Compact High Precision GNSS Antenna (GPS, Beidou, Galileo, Glonass)



Mechanical Outline

TOP VIEW

SIDE VIEW

BOTTOM VIEW

Mechanical Outline
 -Dimensions are in Millimeters
 -Tolerances are Non-Cumulative
 -Dimension tolerance: ±0.20mm[±0.008inch]

Electrical Specifications at 25° C

Part No.	Freq. Range (MHz) FL~FU	Power (W)	Size LxW (mm)	Return Loss Min (dB)	Insertion Loss Max (dB)	Isolation Min (dB)	Phase Balance (deg)	Amplitude Balance Max (dB)
QF1400W06B	1165-1300	5	9.8X7.9	16	1.0	21	90±10.0	±0.5
	1520-1660			14.5	0.7	20	90±9.0	±0.55

Yantel Corporation

Add: No.308-322, 3F, Building 1, Juchuang Jingu Innovation Park, Wenyuan Road 35, Xili Street, Nanshan, Shenzhen, China

Tel: 86-755-8355-1886 Fax: 86-755-8355-2533

For detailed performance specs & shopping online see Yantel web site : www.yantel-corp.com

Preliminary Datasheet

QF1400W06B

Quadrifilar Directional Coupler

1165 MHz- 1300 MHz

1520 MHz- 1660 MHz



Rev A1.0

Hybrid Coupler Pin Configuration

The QF1400W06B has an orientation marker to denote Pin1. Once port one has been identified the other ports are known automatically. Please see the chart below for clarification:

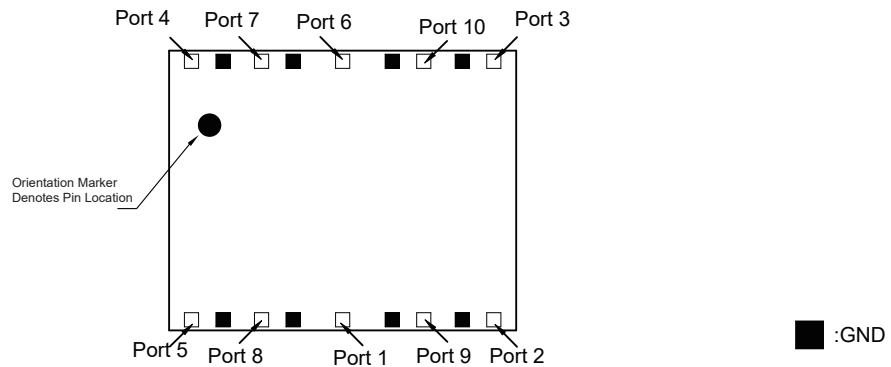

	Port 1	Port 2	Port 3	Port 4	Port 5
1520MHz-1660MHz	Input1	Output1 -6dB, 0°	Output2 -6dB, -90°	Output3 -6dB, -180°	Output4 -6dB, -270°

	Port 6	Port 7	Port 8	Port 9	Port 10
1165MHz-1300MHz	Input2	Output7 -6dB, 0°	Output8 -6dB, -90°	Output9 -6dB, -180°	Output10 -6dB, -270°

Yantel Corporation

Add: No.308-322, 3F, Building 1, Juchuang Jingu Innovation Park, Wenyuan Road 35, Xili Street, Nanshan, Shenzhen, China
 Tel: 86-755-8355-1886 Fax: 86-755-8355-2533

For detailed performance specs & shopping online see Yantel web site : www.yantel-corp.com

Data Sheet

QF1400W06B

Quadrifilar Directional Coupler

1165 MHz- 1300 MHz

1520 MHz- 1660 MHz



Rev A1.0

Typical Performance (-55°C,25°C,95°C,125°C: 1165-1300 MHz)

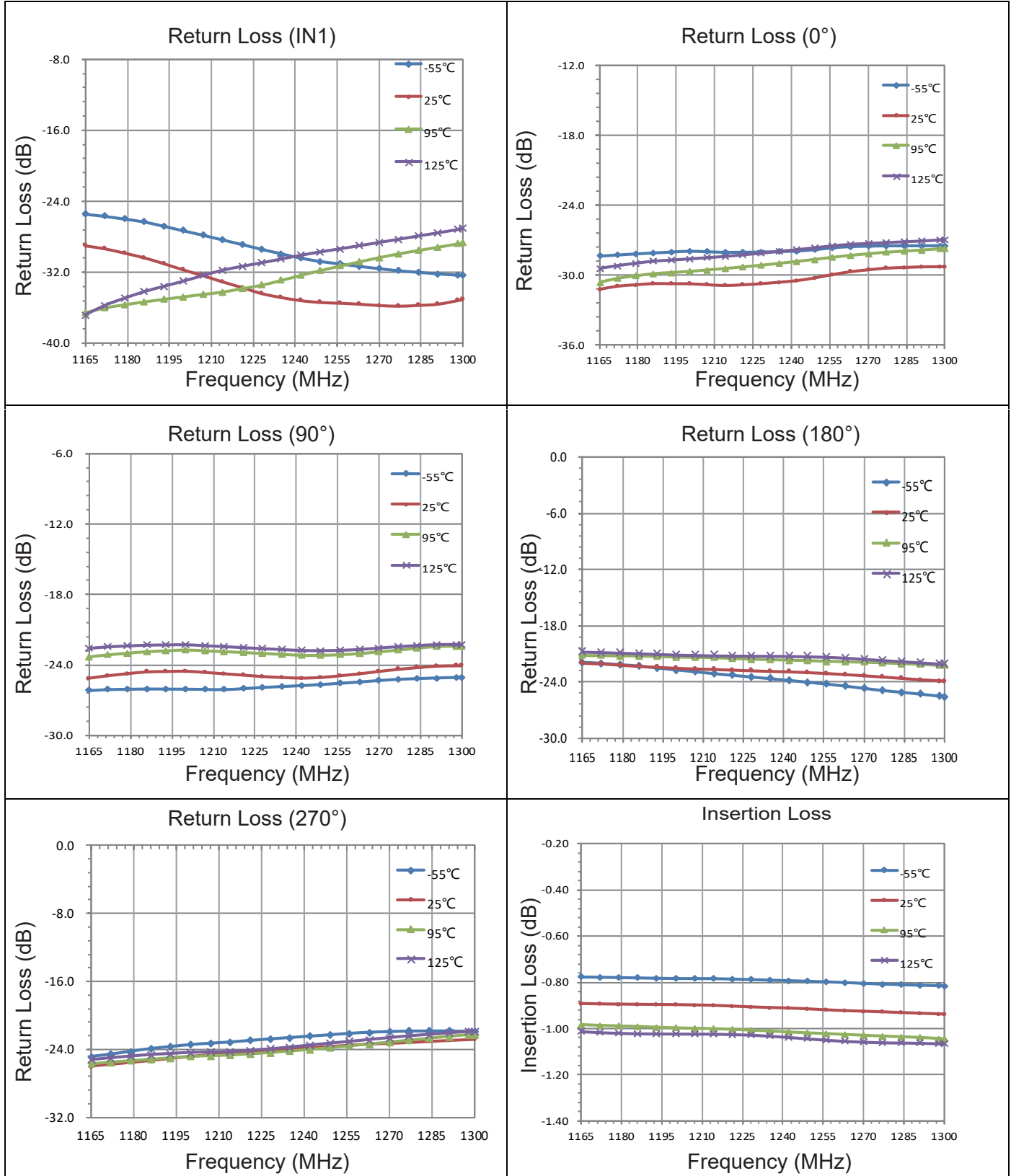

Yantel Corporation

Add: No.308-322, 3F, Building 1, Juchuang Jingu Innovation Park, Wenyuan Road 35, Xili Street, Nanshan, Shenzhen, China

Tel: 86-755-8355-1886 Fax: 86-755-8355-2533

For detailed performance specs & shopping online see Yantel web site : www.yantel-corp.com

Data Sheet

QF1400W06B

Quadrifilar Directional Coupler

1165 MHz- 1300 MHz

1520 MHz- 1660 MHz



Rev A1.0

Typical Performance (-55°C,25°C,95°C,125°C: 1165-1300 MHz)

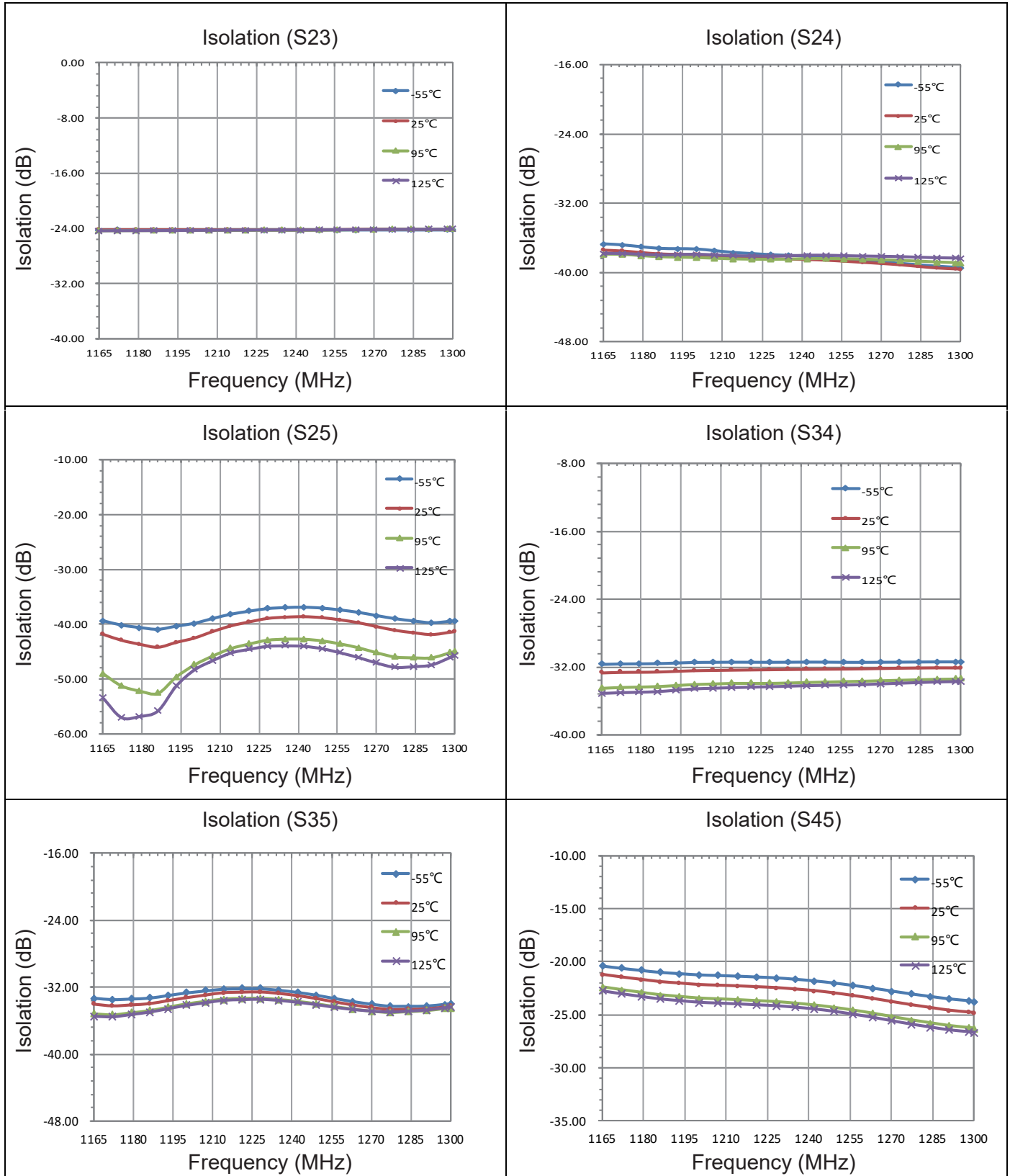

Yantel Corporation

Add: No.308-322, 3F, Building 1, Juchuang Jingu Innovation Park, Wenyuan Road 35, Xili Street, Nanshan, Shenzhen, China

Tel: 86-755-8355-1886 Fax: 86-755-8355-2533

For detailed performance specs & shopping online see Yantel web site : www.yantel-corp.com

Data Sheet

QF1400W06B

Quadrifilar Directional Coupler

1165 MHz- 1300 MHz

1520 MHz- 1660 MHz



Rev A1.0

Typical Performance (-55°C,25°C,95°C,125°C: 1165-1300 MHz)

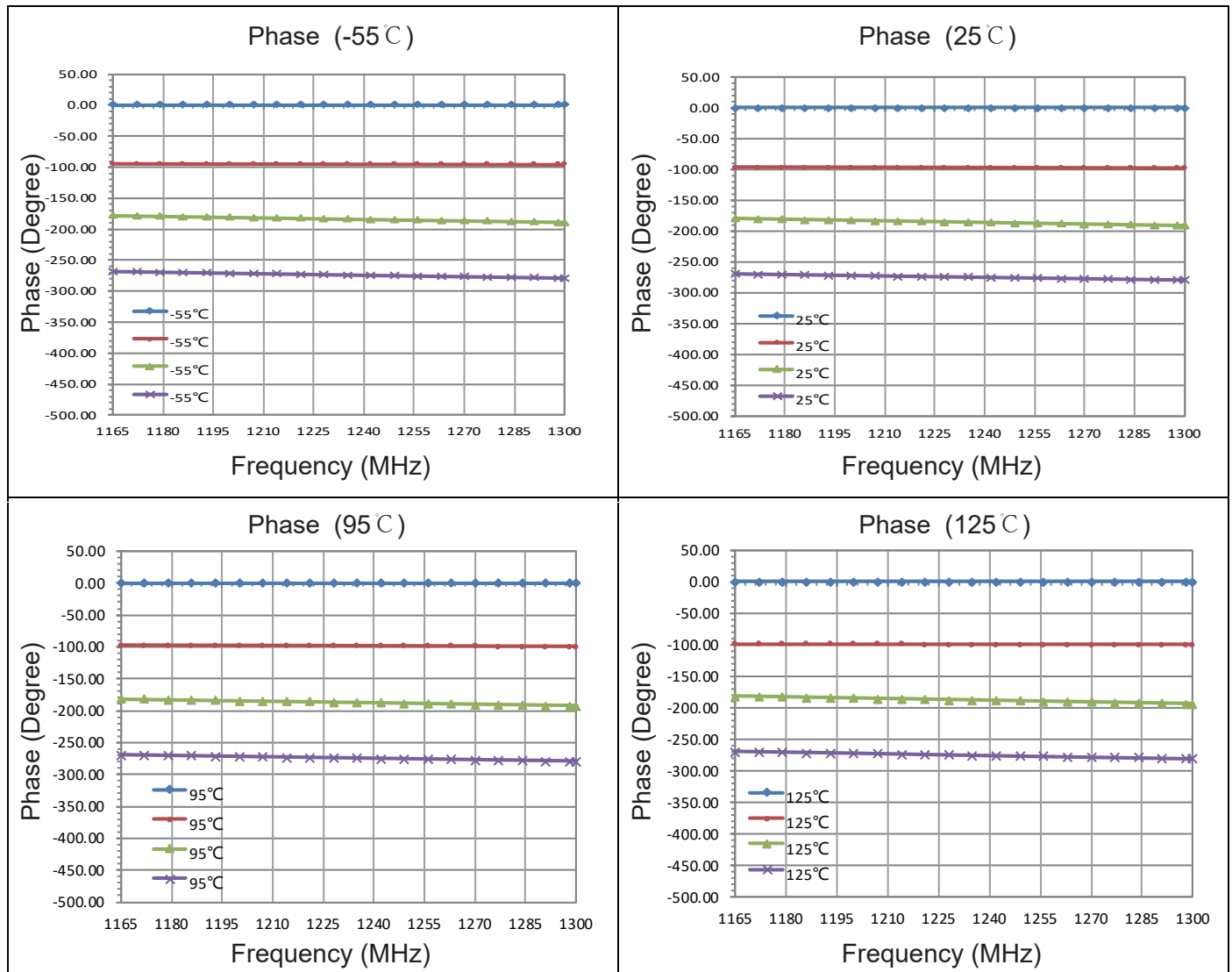

Yantel Corporation

Add: No.308-322, 3F, Building 1, Juchuang Jingu Innovation Park, Wenyuan Road 35, Xili Street, Nanshan, Shenzhen, China

Tel: 86-755-8355-1886 Fax: 86-755-8355-2533

For detailed performance specs & shopping online see Yantel web site : www.yantel-corp.com

Data Sheet

QF1400W06B

Quadrifilar Directional Coupler

1165 MHz- 1300 MHz

1520 MHz- 1660 MHz



Rev A1.0

Typical Performance (-55°C,25°C,95°C,125°C: 1520-1660 MHz)

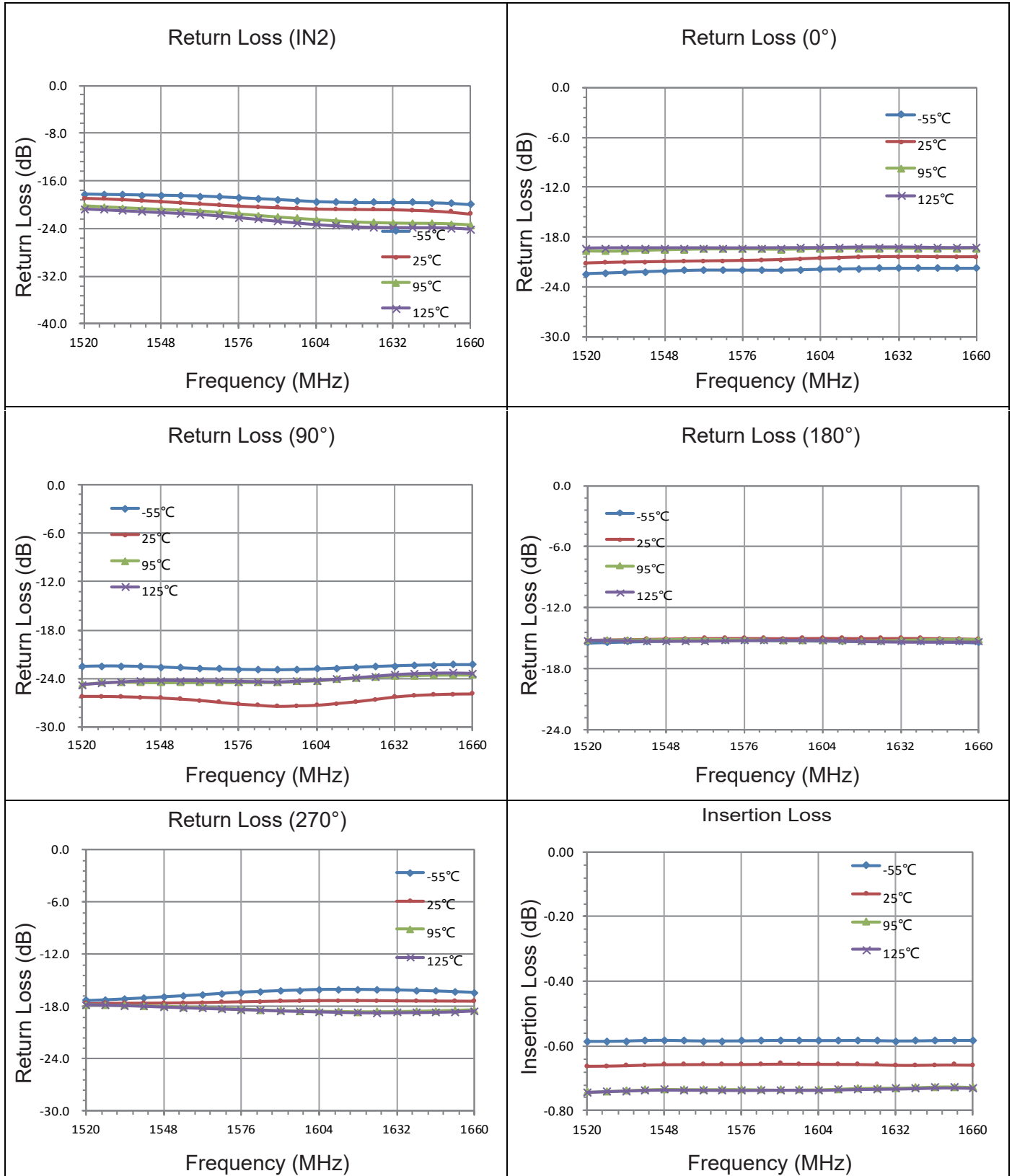

Yantel Corporation

Add: No.308-322, 3F, Building 1, Juchuang Jingu Innovation Park, Wenyuan Road 35, Xili Street, Nanshan, Shenzhen, China

Tel: 86-755-8355-1886 Fax: 86-755-8355-2533

For detailed performance specs & shopping online see Yantel web site : www.yantel-corp.com

Data Sheet

QF1400W06B

Quadrifilar Directional Coupler

1165 MHz- 1300 MHz

1520 MHz- 1660 MHz



Rev A1.0

Typical Performance (-55°C,25°C,95°C,125°C: 1520-1660 MHz)

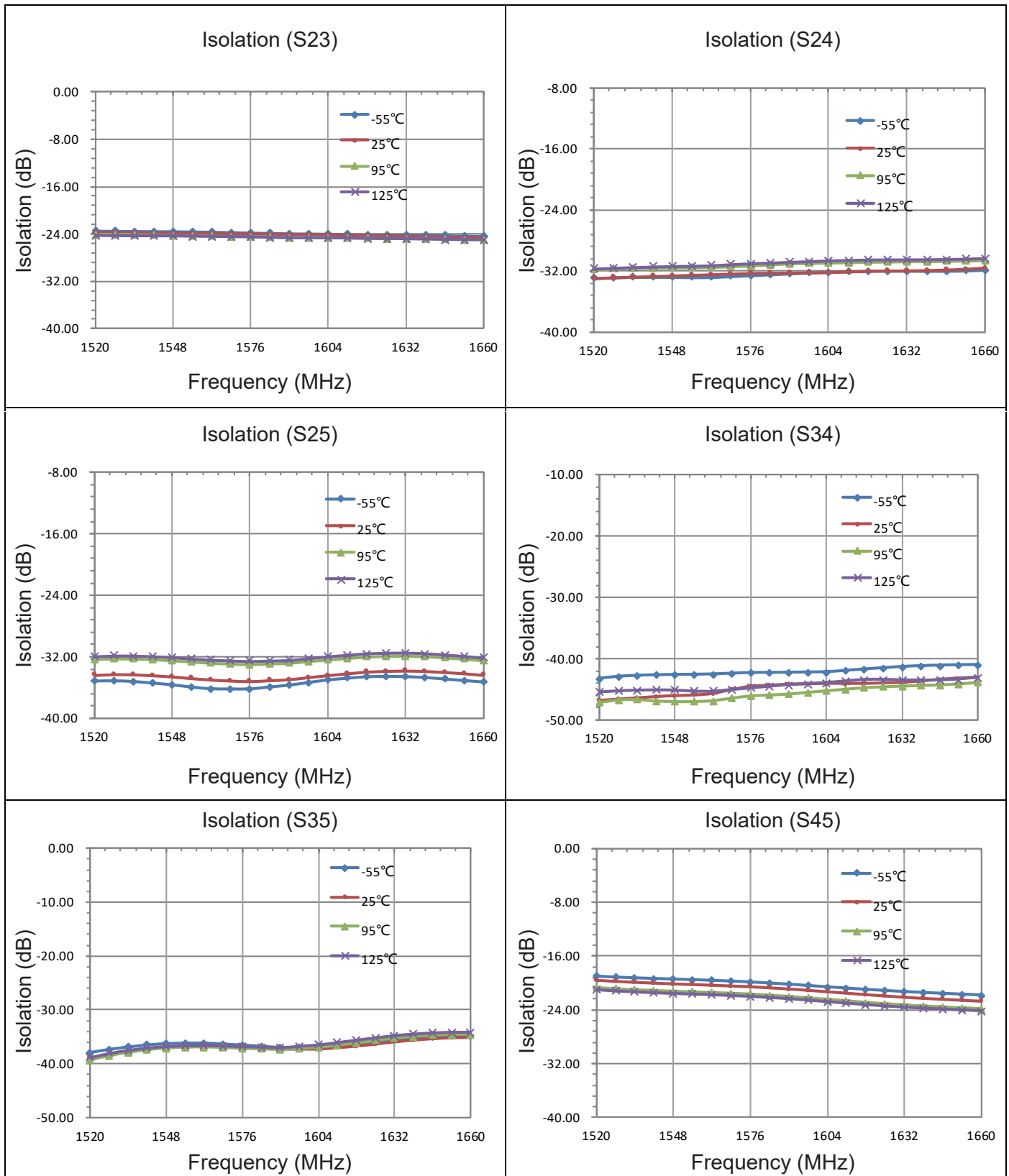

Yantel Corporation

Add: No.308-322, 3F, Building 1, Juchuang Jingu Innovation Park, Wenyuan Road 35, Xili Street, Nanshan, Shenzhen, China

Tel: 86-755-8355-1886 Fax: 86-755-8355-2533

For detailed performance specs & shopping online see Yantel web site : www.yantel-corp.com

Data Sheet

QF1400W06B

Quadrifilar Directional Coupler

1165 MHz- 1300 MHz

1520 MHz- 1660 MHz



Rev A1.0

Typical Performance (-55°C,25°C,95°C,125°C: 1520-1660 MHz)

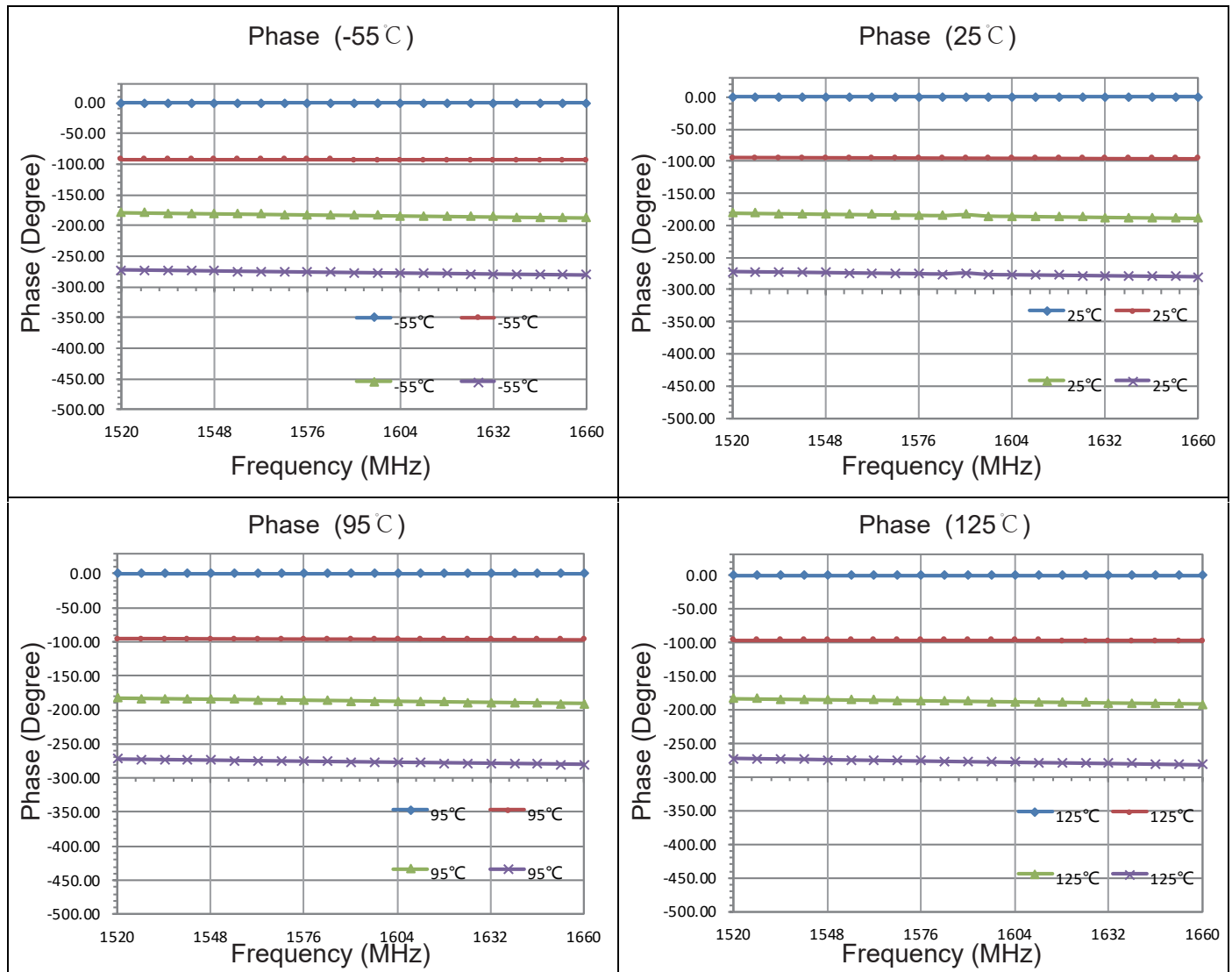

Yantel Corporation

Add: No.308-322, 3F, Building 1, Juchuang Jingu Innovation Park, Wenyuan Road 35, Xili Street, Nanshan, Shenzhen, China

Tel: 86-755-8355-1886 Fax: 86-755-8355-2533

For detailed performance specs & shopping online see Yantel web site : www.yantel-corp.com

Data Sheet

QF1200F06B

Quadrifilar Directional Coupler

1165 MHz- 1300 MHz



Rev A1.1

Recommended PCB Layout

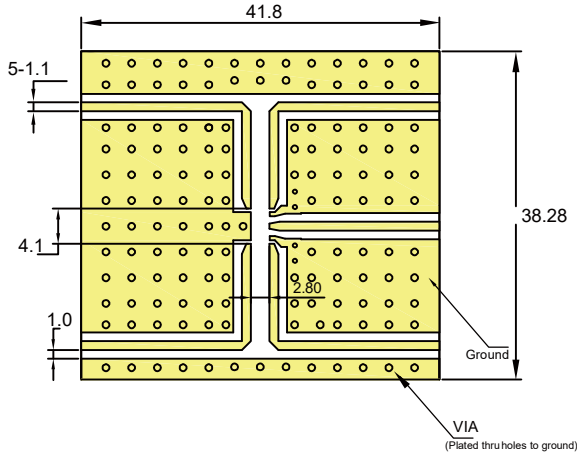

NOTE:

1. 50Ω line width is shown above designing from $Er=3.66$ THK=0.508mm copper 0.5 OZ
2. Bottom side of the PCB is continuous ground plane.
3. All dimensions shown in mm [inch].

Reflow Profile

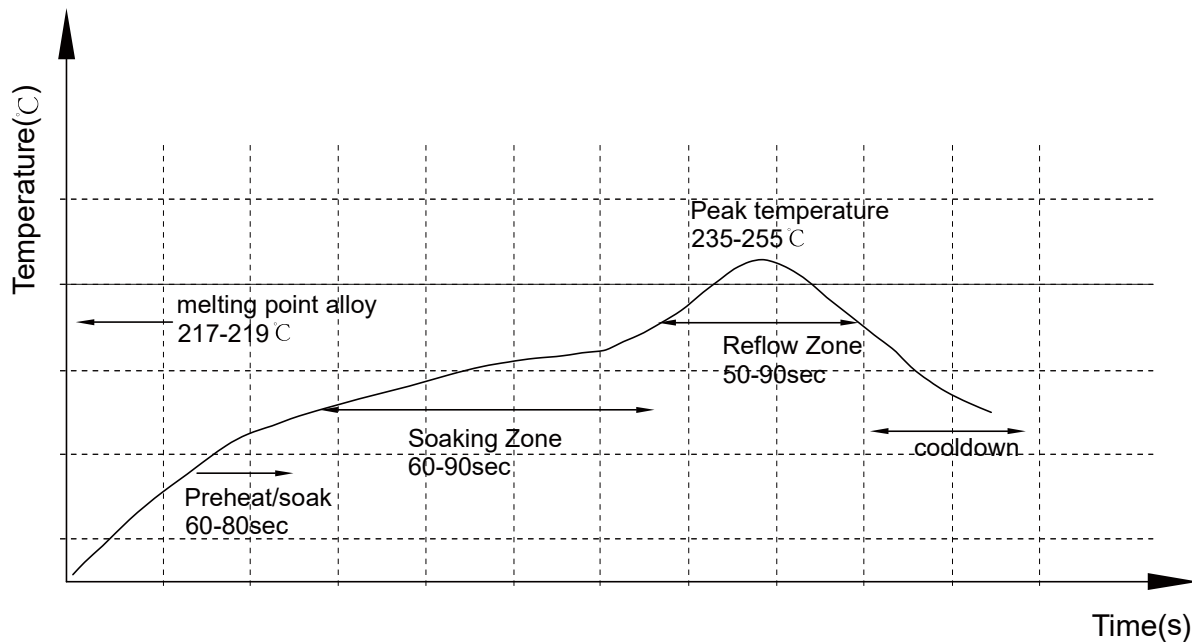

Yantel Corporation

Add: No.308-322, 3F, Building 1, Juchuang Jingu Innovation Park, Wenyuan Road 35, Xili Street, Nanshan, Shenzhen, China
 Tel: 86-755-8355-1886 Fax: 86-755-8355-2533

For detailed performance specs & shopping online see Yantel web site : www.yantel-corp.com

Preliminary Datasheet

QF1400W06B

Quadrifilar Directional Coupler

1165 MHz- 1300 MHz

1520 MHz- 1660 MHz



Rev A1.0

Definition of Measured Specifications

	S-Parameter(dB)	Power Method[dB]
Output 1	S ₂₁	$10 \cdot \log \left(\frac{P_{out1}}{P_{in}} \right)$
Output 2	S ₃₁	$10 \cdot \log \left(\frac{P_{out2}}{P_{in}} \right)$
Output 3	S ₄₁	$10 \cdot \log \left(\frac{P_{out3}}{P_{in}} \right)$
Output 4	S ₅₁	$10 \cdot \log \left(\frac{P_{out4}}{P_{in}} \right)$
Insertion Loss		$10 \cdot \log \left(\frac{P_{in}}{P_{out1+out2+out3+out4}} \right)$
Amplitude Balance		$10 \cdot \log \left(\frac{P_{out1-out4}}{\frac{P_{out1+out2+out3+out4}}{2}} \right)$
Isolation 1	S ₂₃	$10 \cdot \log \left(\frac{P_{out3}}{P_{out2}} \right)$
Isolation 2	S ₂₄	$10 \cdot \log \left(\frac{P_{out4}}{P_{out2}} \right)$
Isolation 3	S ₂₅	$10 \cdot \log \left(\frac{P_{out5}}{P_{out2}} \right)$
Isolation 4	S ₃₄	$10 \cdot \log \left(\frac{P_{out4}}{P_{out3}} \right)$
Isolation 5	S ₃₅	$10 \cdot \log \left(\frac{P_{out5}}{P_{out3}} \right)$
Isolation 6	S ₄₅	$10 \cdot \log \left(\frac{P_{out5}}{P_{out4}} \right)$
Phase Balance 1(0°)	Phase (S ₂₁)	
Phase Balance 2(-90°)	Phase (S ₃₁) -Phase (S ₂₁)	
Phase Balance 2(-180°)	Phase (S ₄₁) -Phase (S ₂₁)	
Phase Balance 2(-270°)	Phase (S ₅₁) -Phase (S ₂₁)	

P_{in} : Power of Input Port1

P_{out1}: Power of output Port2

P_{out2}: Power of output Port3

P_{out3}: Power of output Port4

P_{out4}: Power of output Port5

Yantel Corporation

Add: No.308-322, 3F, Building 1, Juchuang Jingu Innovation Park, Wenyuan Road 35, Xili Street, Nanshan, Shenzhen, China

Tel: 86-755-8355-1886 Fax: 86-755-8355-2533

For detailed performance specs & shopping online see Yantel web site : www.yantel-corp.com

Preliminary Datasheet

QF1400W06B

Quadrifilar Directional Coupler

1165 MHz- 1300 MHz

1520 MHz- 1660 MHz



Rev A1.0

Recommended PCB Layout

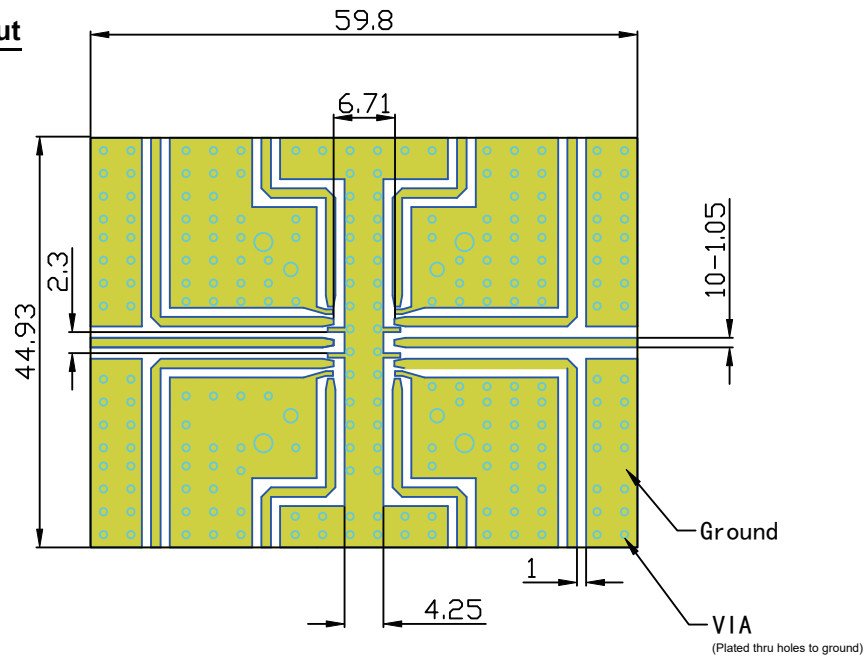

NOTE:

1. 50Ω line width is shown above designing from $\epsilon_r=3.66$ THK=0.508mm copper 0.5 OZ
2. Bottom side of the PCB is continuous ground plane.
3. All dimensions shown in mm [inch].

Reflow Profile

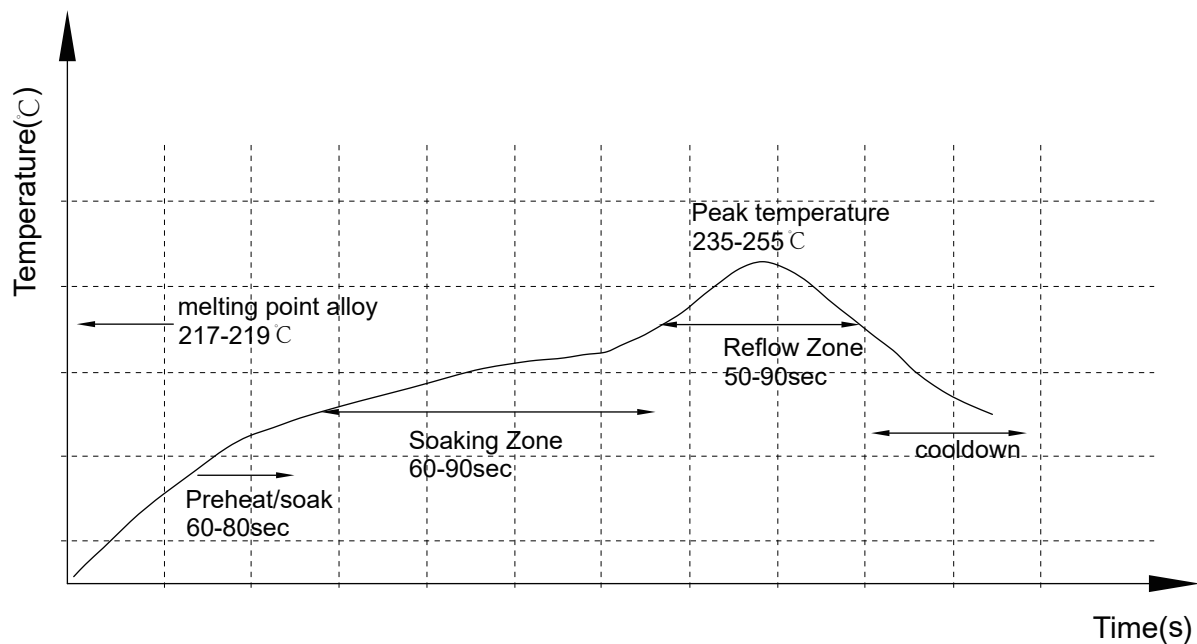

Yantel Corporation

Add: No.308-322, 3F, Building 1, Juchuang Jingu Innovation Park, Wenyuan Road 35, Xili Street, Nanshan, Shenzhen, China
Tel: 86-755-8355-1886 Fax: 86-755-8355-2533

For detailed performance specs & shopping online see Yantel web site : www.yantel-corp.com

Preliminary Datasheet

QF1400W06B

Quadrifilar Directional Coupler

1165 MHz- 1300 MHz

1520 MHz- 1660 MHz



Rev A1.0

Reliability Test Flow

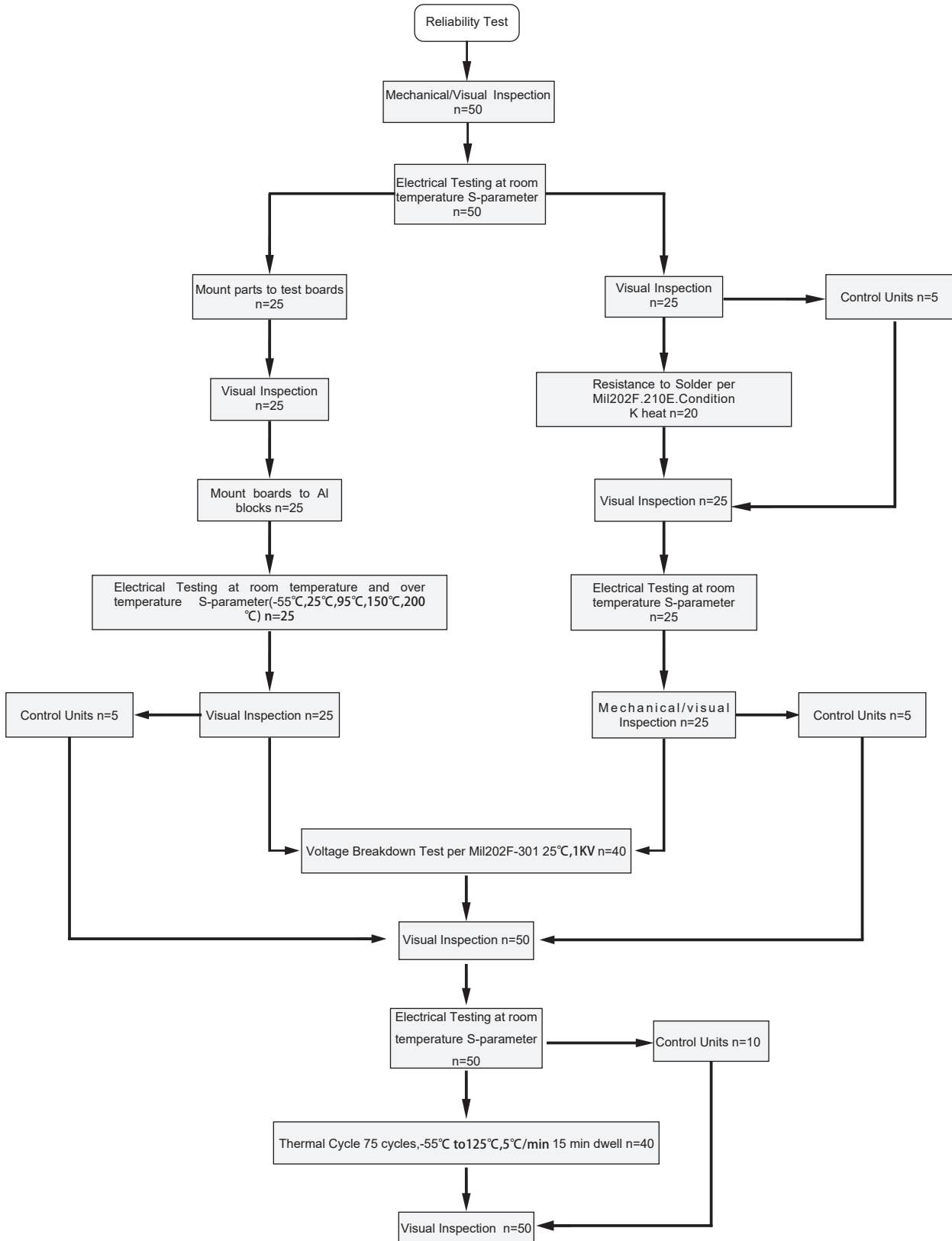

Yantel Corporation

Add: No.308-322, 3F, Building 1, Juchuang Jingu Innovation Park, Wenyuan Road 35, Xili Street, Nanshan, Shenzhen, China
Tel: 86-755-8355-1886 Fax: 86-755-8355-2533

For detailed performance specs & shopping online see Yantel web site : www.yantel-corp.com

Preliminary Datasheet

QF1400W06B

Quadrifilar Directional Coupler

1165 MHz- 1300 MHz

1520 MHz- 1660 MHz



Rev A1.0

Reliability Test Flow

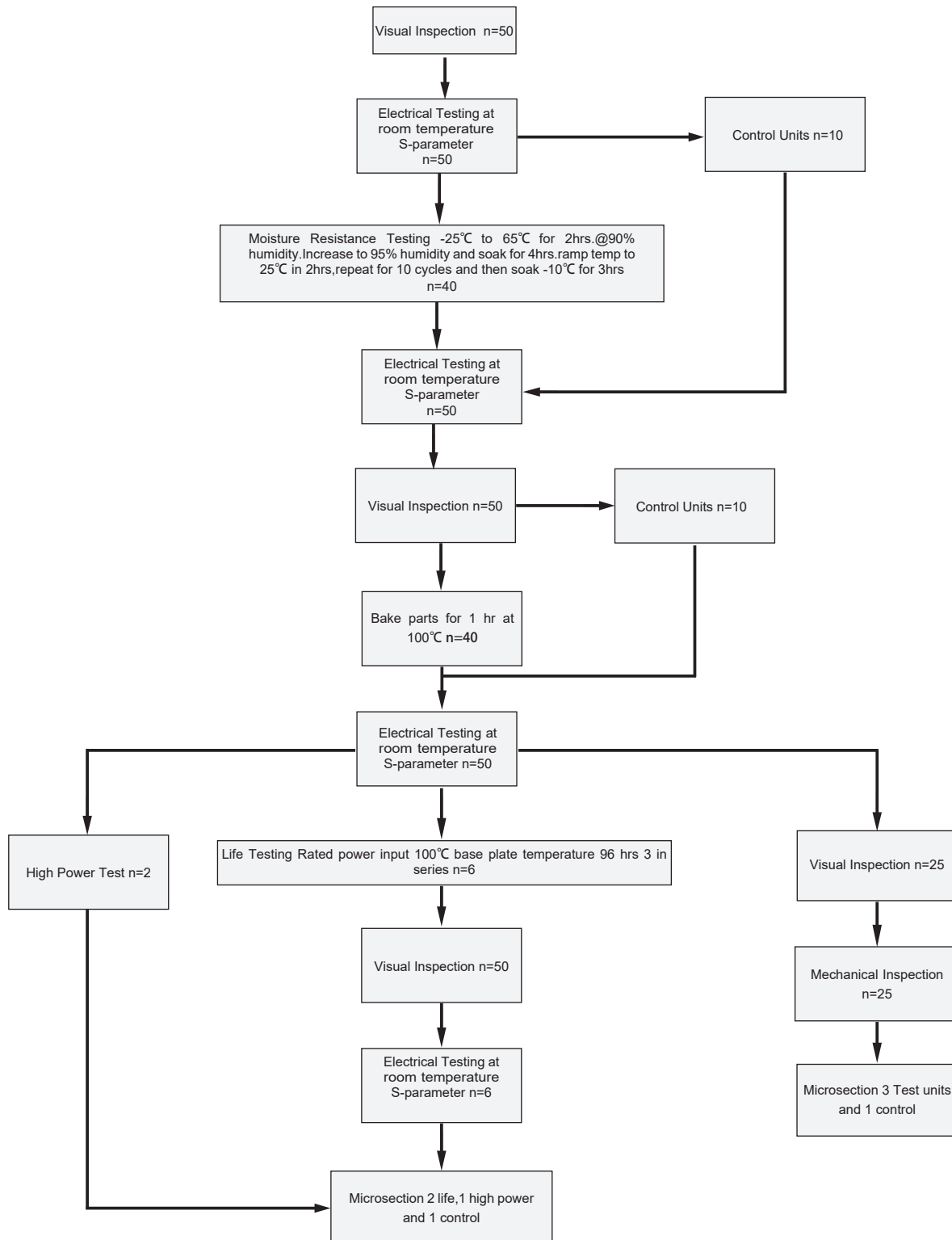

Yantel Corporation

Add: No.308-322, 3F, Building 1, Juchuang Jingu Innovation Park, Wenyuan Road 35, Xili Street, Nanshan, Shenzhen, China

Tel: 86-755-8355-1886 Fax: 86-755-8355-2533

For detailed performance specs & shopping online see Yantel web site : www.yantel-corp.com

Preliminary Datasheet

QF1400W06B

Quadrifilar Directional Coupler

1165 MHz- 1300 MHz

1520 MHz- 1660 MHz



Rev A1.0

Tape and Reel Drawing

Feeding Direction

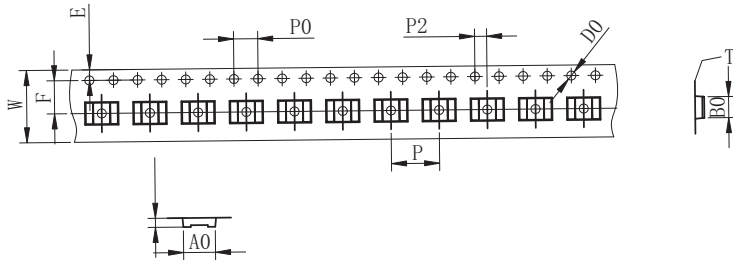

ITEM	W	A0	B0	K0	K1	P	F	E	D	P0	P2	t	13°
DIM	12.0	10	8.5	1.0		11	10	1.75	1.50	4.00	2.00	0.3	长/盘 元件/盘
TOLE	+0.30 -0.30	+0.10 -0.10	+0.10 -0.10	+0.10 -0.10	+0.10 -0.10	+0.10 -0.10	+0.10 -0.10	+0.10 -0.10	+0.10 -0.00	+0.10 -0.10	+0.10 -0.10	+0.05 -0.05	55M 6000 PCS

Notice:

- A. 10 Sprocket hole pitch cumulative tolerance is 0.2mm.
- B. Carrier camber shall be not more than 1mm per 100mm through a length of 250mm.
- C. All dimensions meet EIA-418-B requirements.
- D. A0 & B0 measured as indicated.
- E. K0 measured from a place on the inside bottom of the pocket to top surface of carrier.
- F. Material: PE 100
- G. Thickness: 0.30±0.05mm
- H. 1000 units (maximum) / T&R

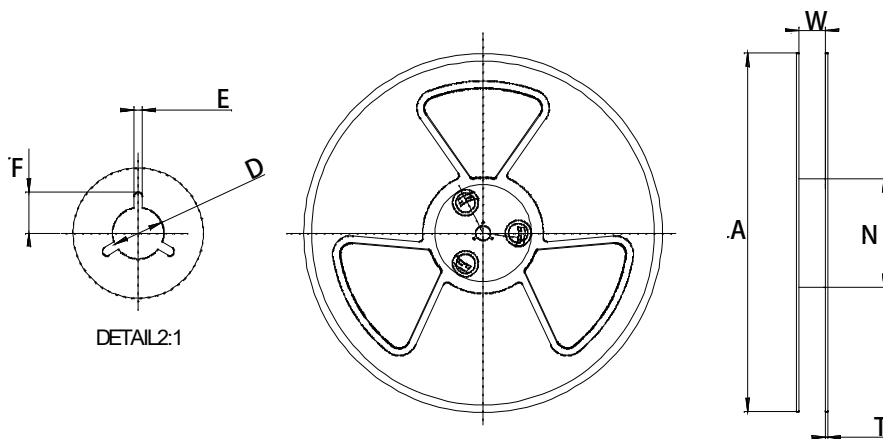

Symbol	Dimensions(mm)
W	12.5±0.4
A	177±0.5
N	63±0.3
T	1.8±0.2
E	2.1±0.3
F	10.75±0.3
D	13.5+0.5/-0.2

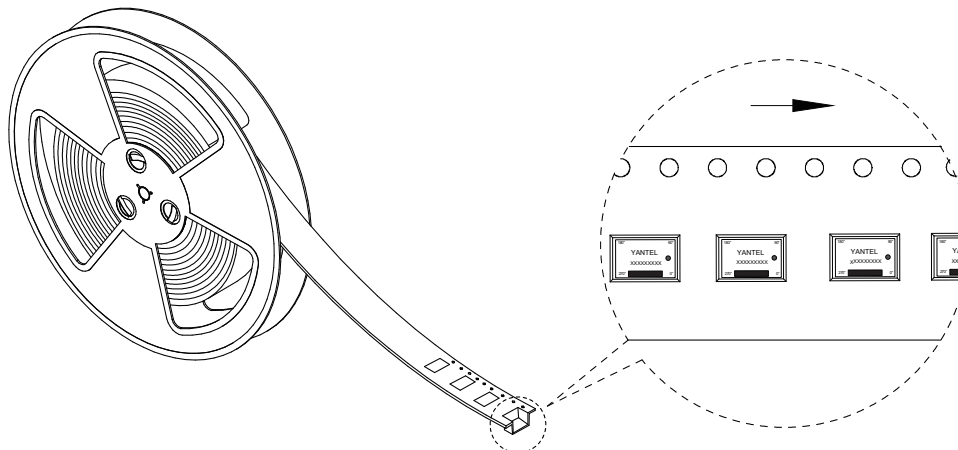

Yantel Corporation

Add: No.308-322, 3F, Building 1, Juchuang Jingu Innovation Park, Wenyuan Road 35, Xili Street, Nanshan, Shenzhen, China

Tel: 86-755-8355-1886 Fax: 86-755-8355-2533

For detailed performance specs & shopping online see Yantel web site : www.yantel-corp.com