

Description

The products are widely used in China and global 4G/5G base station, 5G network coverage, BeiDou navigation antenna, vehicle-mounted high-precision navigation (unmanned) antenna and other applications. The products have miniaturization, low-loss, wide-bandwidth, high power density, high reliability, high cost-effective and other competitive advantages.

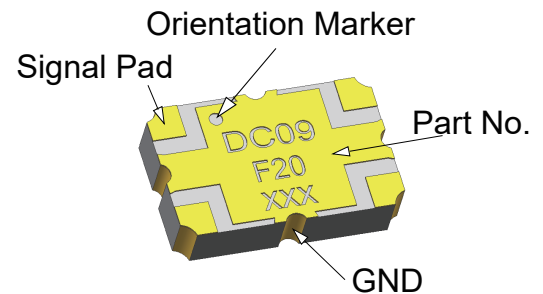

Features:

- 700-1000 MHz
- 4G/5G base station
- High Power
- Very Low Loss
- Tight Amplitude Balance
- High Isolation
- Production Friendly
- Tape and Reel

Electrical Specifications

Frequency MHz	Coupling dB	Directivity dB Min	VSWR Max : 1
700 - 1000	20.0±1.2	18.0	1.38
869 - 894	19.5±0.5	18.0	1.25
925 - 960	19.5±0.5	18.0	1.35
Insertion Loss dB Max	Power Avg. CW Watts @95degC	Operating Temp. °C	
0.075	25	-55 to +140	
0.05	25	-55 to +140	
0.05	25	-55 to +140	

Notes:

1. All the above data are based on specified demo board.
2. Insertion loss: Thru board loss has been removed.

Mechanical Outline

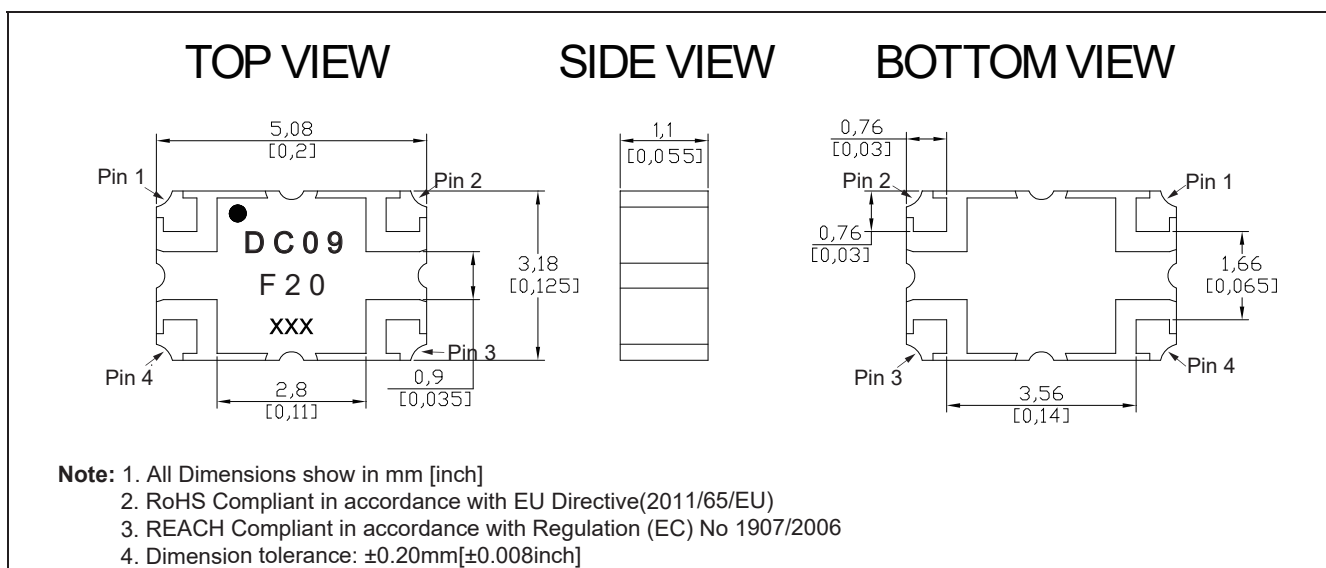

Yantel Corporation

Add: No.308-322, 3F, Building 1, Juchuang Jingu Innovation Park, Wenyuan Road 35, Xili Street, Nanshan, Shenzhen, China
Tel: 86-755-8355-1886 Fax: 86-755-8355-2533

For detailed performance specs & shopping online see Yantel web site : www.yantel-corp.com

Directional Coupler Pin Configuration

The DC09F20 has an orientation marker to denote Pin1. Once port one has been identified the other ports are known automatically. Please see the chart below for clarification:

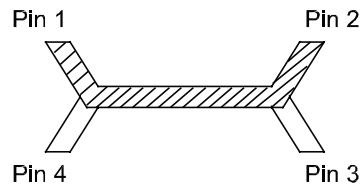

Pin 1	Pin 2	Pin 3	Pin 4
Input	Transmission	Isolate	Coupling
Transmission	Input	Coupling	Isolate

Typical Performance Data (@25°C)

Frequency (MHz)	Coupling (dB)	Transmission (dB)	Insertion Loss (dB)	Directivity (dB)	Return Loss(dB)			
					S11	S22	S33	S44
700	-20.62	-0.06	-0.02	-22.92	-31.80	-31.18	-21.52	-21.71
715	-20.50	-0.06	-0.02	-22.76	-31.65	-31.30	-21.29	-21.48
730	-20.39	-0.06	-0.02	-22.62	-31.51	-31.22	-21.16	-21.35
745	-20.28	-0.06	-0.02	-22.46	-31.38	-31.36	-21.09	-21.18
760	-20.17	-0.06	-0.02	-22.35	-31.36	-31.34	-20.95	-21.04
775	-20.06	-0.06	-0.02	-22.33	-31.66	-31.48	-20.83	-20.92
790	-19.97	-0.07	-0.02	-22.22	-31.73	-31.25	-20.77	-20.87
805	-19.88	-0.07	-0.02	-21.94	-31.85	-31.39	-20.57	-20.76
820	-19.79	-0.07	-0.02	-21.81	-31.73	-31.36	-20.48	-20.59
835	-19.71	-0.07	-0.02	-21.77	-31.73	-31.38	-20.39	-20.45
850	-19.62	-0.07	-0.02	-21.62	-31.83	-31.39	-20.30	-20.35
865	-19.55	-0.07	-0.02	-21.53	-31.64	-31.13	-20.27	-20.28
880	-19.48	-0.07	-0.02	-21.34	-31.78	-31.24	-20.22	-20.21
895	-19.42	-0.07	-0.02	-21.14	-32.09	-31.47	-20.10	-20.12
910	-19.36	-0.08	-0.03	-21.06	-31.92	-31.32	-20.02	-20.03
925	-19.31	-0.08	-0.03	-20.89	-32.10	-31.13	-19.89	-19.93
940	-19.25	-0.08	-0.03	-20.79	-32.01	-31.41	-19.79	-19.76
955	-19.21	-0.08	-0.03	-20.62	-32.04	-31.64	-19.73	-19.65
970	-19.17	-0.08	-0.03	-20.48	-31.92	-31.75	-19.62	-19.60
985	-19.13	-0.08	-0.03	-20.36	-31.96	-31.80	-19.52	-19.50
1000	-19.09	-0.08	-0.03	-20.22	-32.16	-31.82	-19.47	-19.39

Yantel Corporation

Add: No.308-322, 3F, Building 1, Juchuang Jingu Innovation Park, Wenyuan Road 35, Xili Street, Nanshan, Shenzhen, China
 Tel: 86-755-8355-1886 Fax: 86-755-8355-2533

For detailed performance specs & shopping online see Yantel web site : www.yantel-corp.com

Power Derating Curves

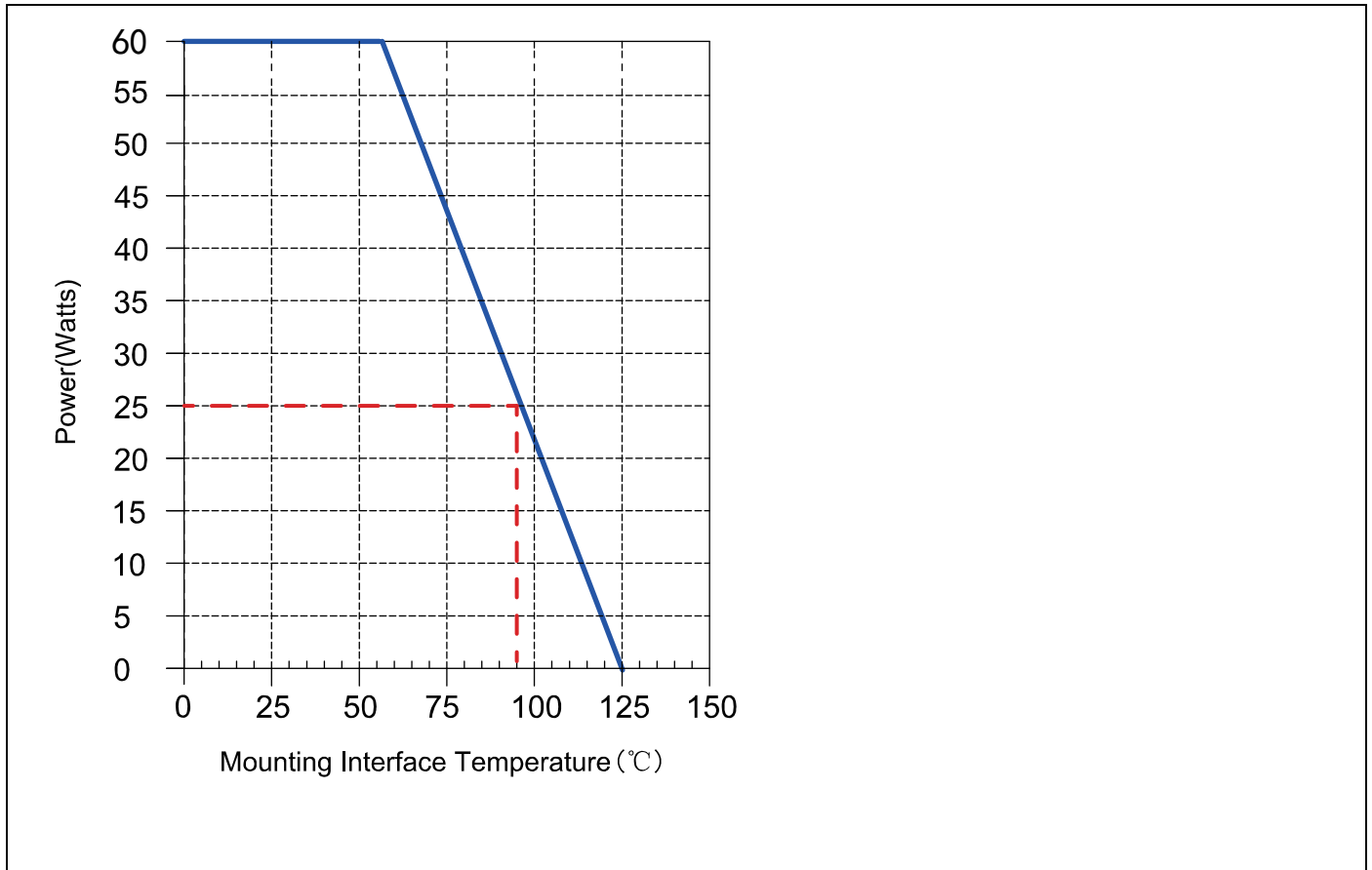

Power Derating:

The power handling and corresponding power derating plots are a function of the thermal resistance, mounting surface temperature (base plate temperature), maximum continuous operating temperature of the coupler, and the thermal insertion loss. The thermal insertion loss is defined in the Power Handling section of the data sheet. As the mounting interface temperature approaches the maximum continuous operating temperature, the power handling decreases to zero.

If mounting temperature is greater than 95°C, Xinger coupler will perform reliably as long as the input power is derated to the curve above..

Yantel Corporation

Add: No.308-322, 3F, Building 1, Juchuang Jingu Innovation Park, Wenyuan Road 35, Xili Street, Nanshan, Shenzhen, China
Tel: 86-755-8355-1886 Fax: 86-755-8355-2533

For detailed performance specs & shopping online see Yantel web site : www.yantel-corp.com

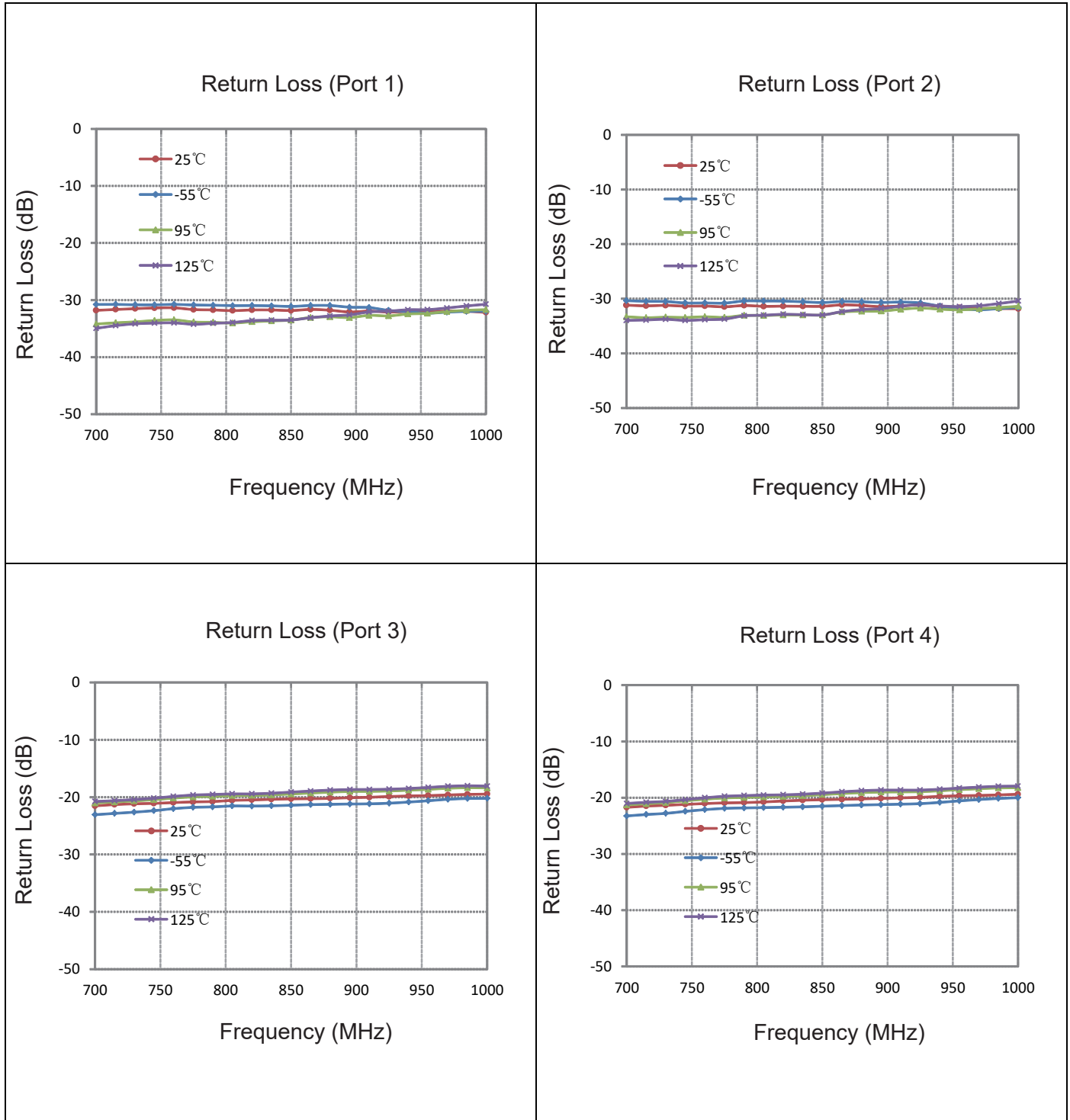
Typical Performance (-55°C, 25°C, 95°C, 125°C:700-1000 MHz)

Yantel Corporation

 Add: No.308-322, 3F, Building 1, Juchuang Jingu Innovation Park, Wenyuan Road 35, Xili Street, Nanshan, Shenzhen, China
 Tel: 86-755-8355-1886 Fax: 86-755-8355-2533

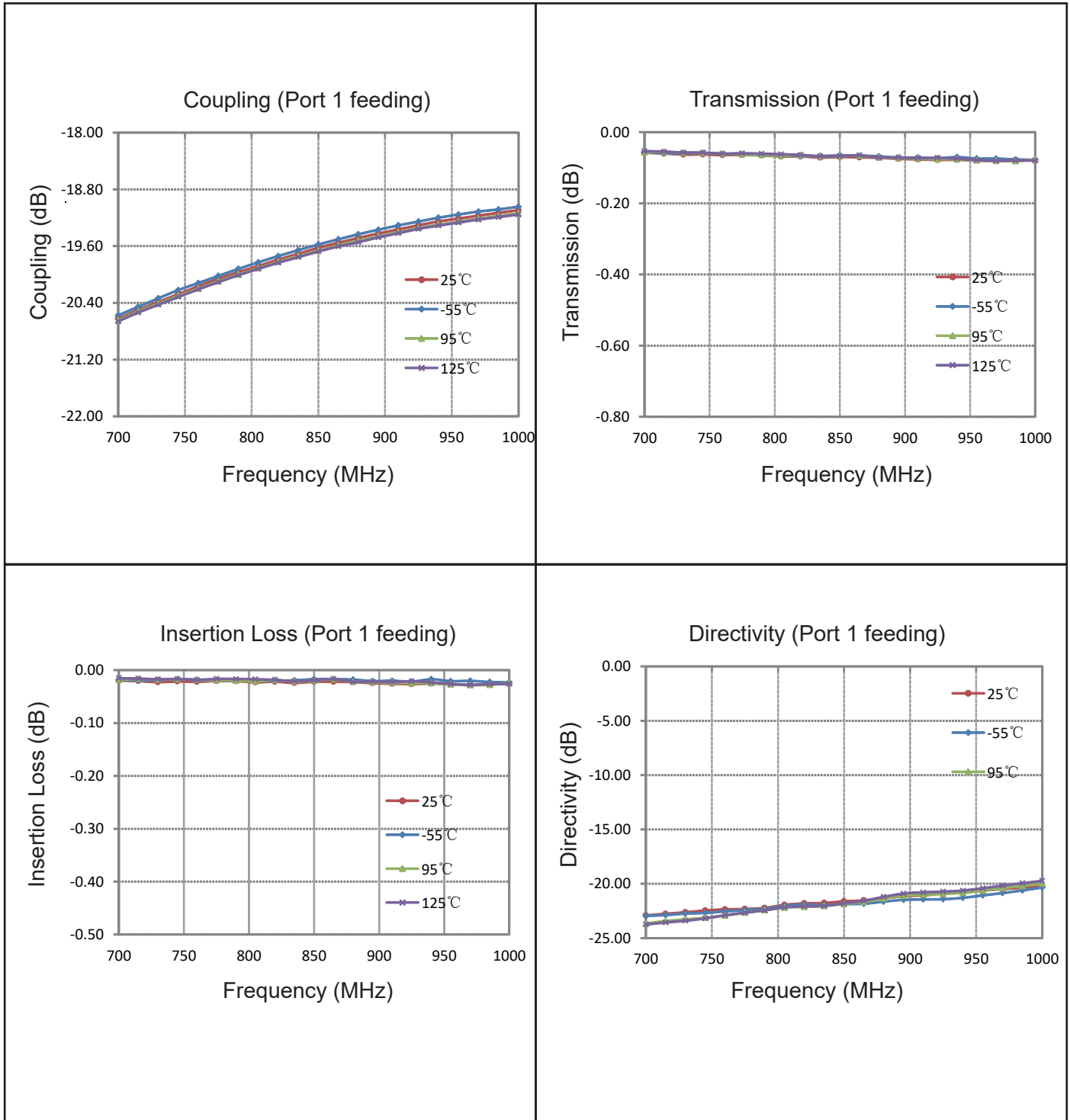
 For detailed performance specs & shopping online see Yantel web site : www.yantel-corp.com

Typical Performance (-55°C, 25°C, 95°C&125°C:700-1000 MHz)

Yantel Corporation

 Add: No.308-322, 3F, Building 1, Juchuang Jingu Innovation Park, Wenyuan Road 35, Xili Street, Nanshan, Shenzhen, China
 Tel: 86-755-8355-1886 Fax: 86-755-8355-2533

 For detailed performance specs & shopping online see Yantel web site : www.yantel-corp.com

Description of Measured Specifications

Parameter	Description
VSWR	Voltage standing wave ratio, the impedance match to 50 Ω , the ideal value is 1:1.
Return Loss	Loss of signal power resulting from the reflection caused by discontinuity of transmission line.
Insertion Loss	The input power divided by sum of power at the coupling port & transmission port.
Coupling	The input power divided by the power at coupling port.
Transmission	The input power divided by the power at transmission port.
Directivity	The power at the coupling port divided by the power at the isolated.

Test Method

1. Calibrating your vector network analyzer.
2. Connect the VNA 4 Port to DUT respectively.
3. Measure the data of coupling through port 1 to port 4(S41).
4. Measure the data of transmission through port 1 to port 2(S21).
5. Measure the data of isolation through port 1 to port 3(S31).
6. Measure the data of return loss port 1, port 2, port 3 & port 4.
7. According to the above data to calculate insertion loss, directivity.

Note:

1. When calculating insertion loss at room temperature, coupling & transmission data both need remove demo board loss. Please see demo board loss data below the table :

Frequency Range(MHz)	Demo Board Loss (dB) @25°C
470-860	0.06~0.10
800-1000	0.10~0.15
1200-1700	0.15~0.20
1700-2000	0.20~0.25
2000-2300	0.20~0.25
2300-2700	0.25~0.30

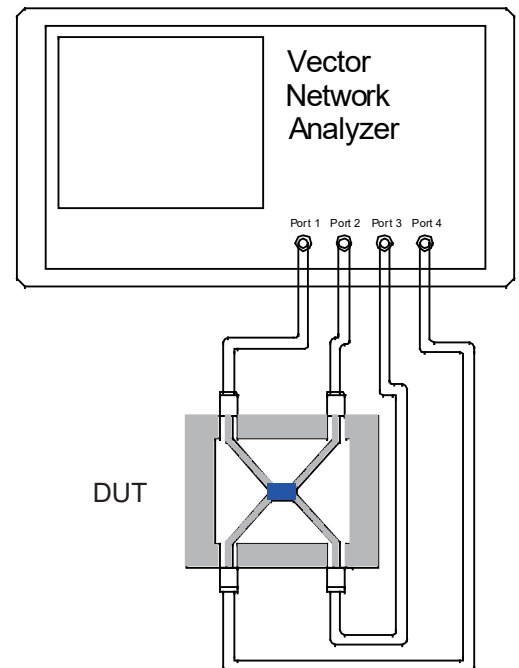

Recommended PCB Layout

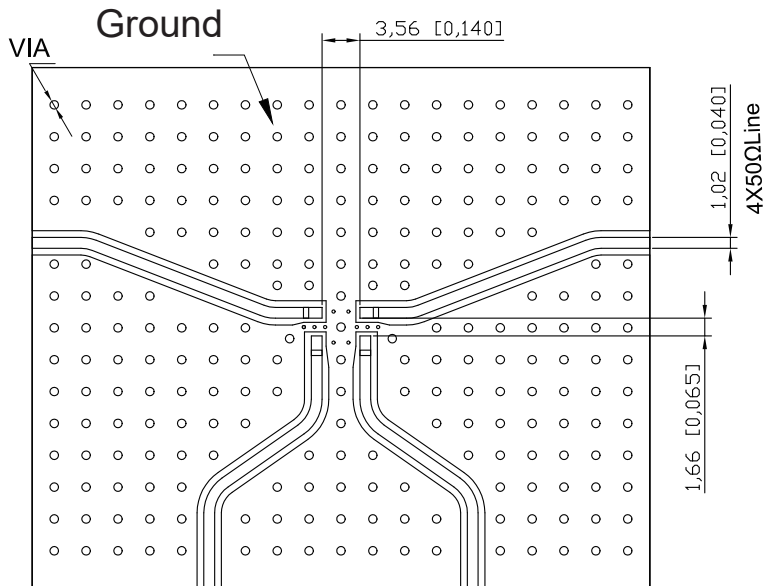

NOTE:

1. 50Ω line width is shown above designing from $\epsilon_r=3.66$ THK=20mil copper 1 OZ
2. Bottom side of the PCB is continuous ground plane.
3. All dimensions shown in mm [inch].

Reflow Profile

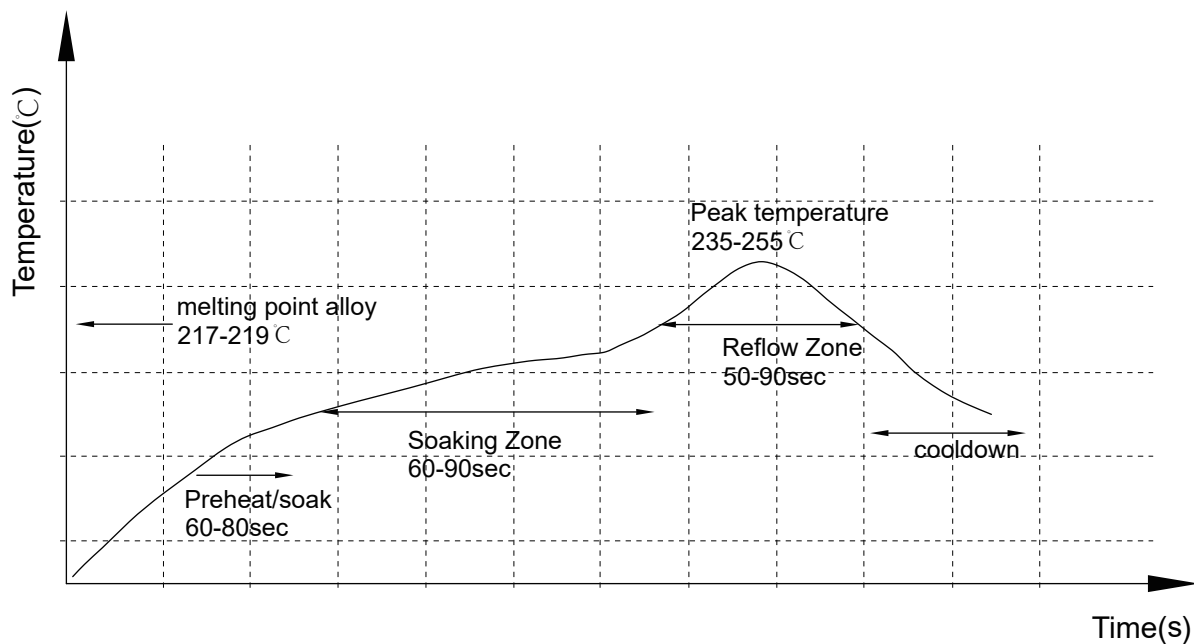

Yantel Corporation

Add: No.308-322, 3F, Building 1, Juchuang Jingu Innovation Park, Wenyuan Road 35, Xili Street, Nanshan, Shenzhen, China
 Tel: 86-755-8355-1886 Fax: 86-755-8355-2533

For detailed performance specs & shopping online see Yantel web site : www.yantel-corp.com

Reliability Test Flow

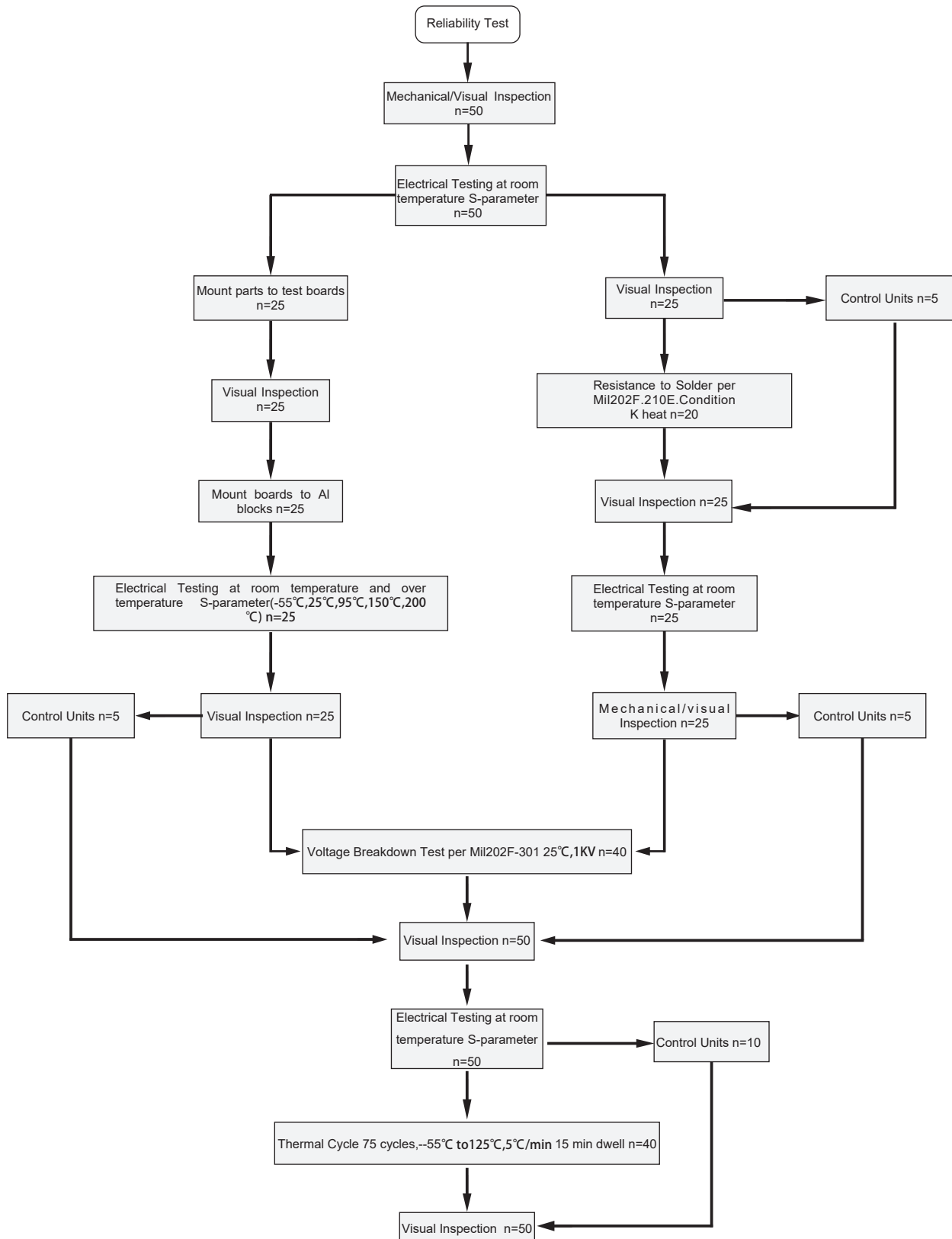

Reliability Test Flow

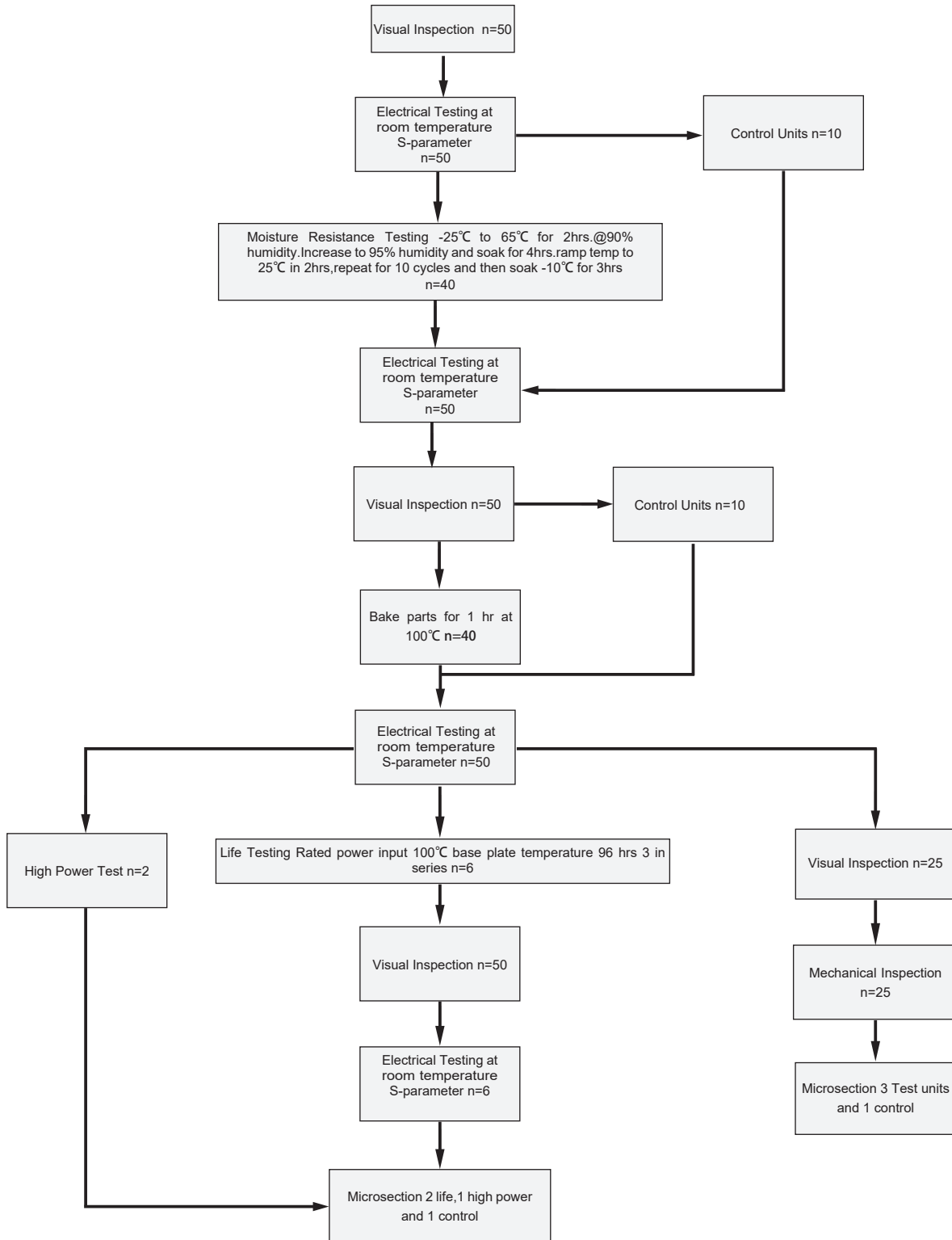

Tape and Reel Drawing

Feeding Direction

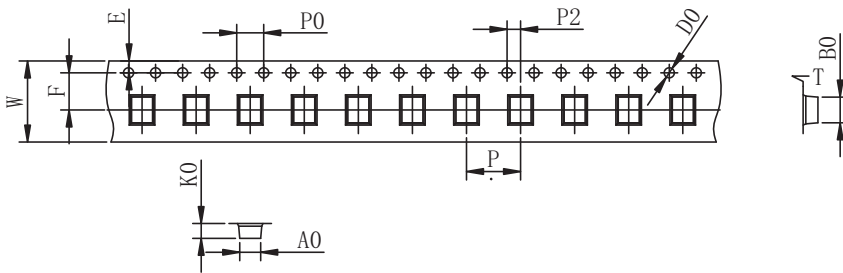

ITEM	W	A0	B0	K0	K1	P	F	E	D	P0	P2	t	7"
DIM(mm)	12.0	3.45	5.35	1.5		8	5.5	1.75	1.50	4.00	2.00	0.30	P/R
TOLE	+0.30 -0.30	+0.10 -0.10	+0.10 -0.10	+0.10 -0.10	+0.10 -0.10	+0.10 -0.10	+0.10 -0.10	+0.10 -0.10	+0.10 -0.00	+0.10 -0.10	+0.10 -0.10	+0.05 -0.05	1000pcs

Notice:

- A.10 Sprocket hole pitch cumulative tolerance is 0.2mm.
- B. Carrier camber shall be not more than 1mm per 100mm through a length of 250mm.
- C. All dimensions meet EIA-418-B requirements.
- D. A0 & B0 measured as indicated.
- E. K0 measured from a place on the inside bottom of the pocket to top surface of carrier.
- F. Material: PE 100
- G. Thickness: 0.30±0.05mm
- H. 1000 units (maximum) / T&R

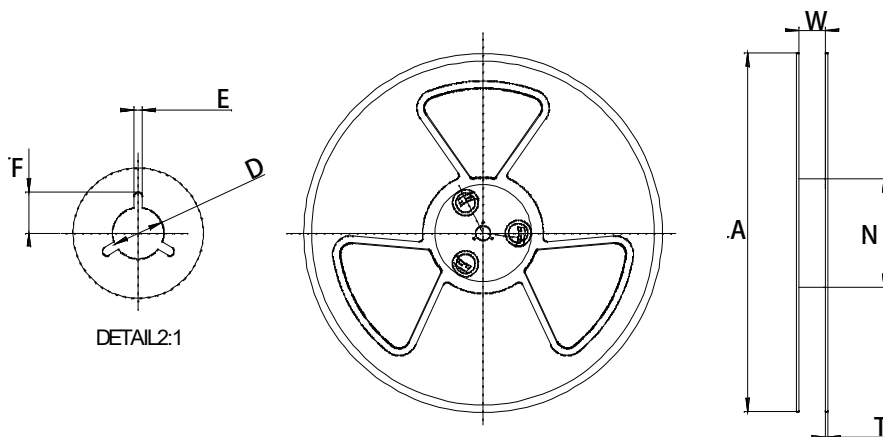

Symbol	Dimensions(mm)
W	12.5±0.4
A	177±0.5
N	63±0.3
T	1.8±0.2
E	2.1±0.3
F	10.75±0.3
D	13.5+0.5/-0.2

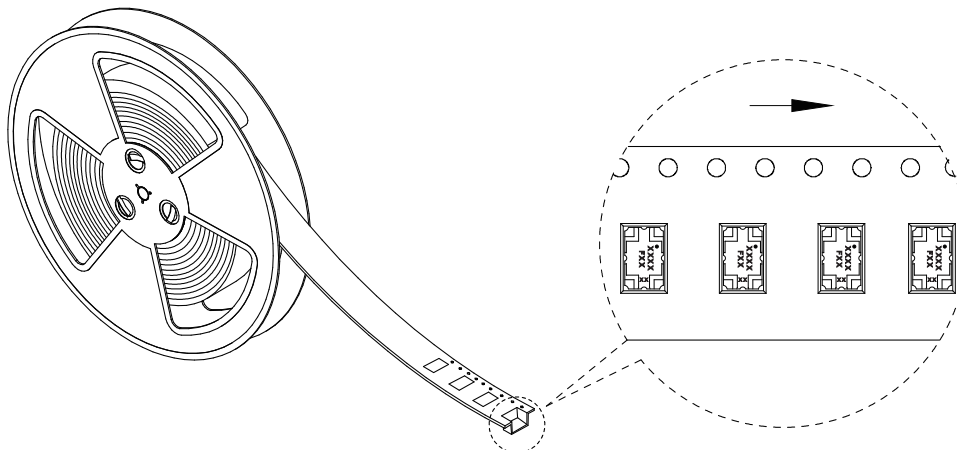

Yantel Corporation

 Add: No.308-322, 3F, Building 1, Juchuang Jingu Innovation Park, Wenyuan Road 35, Xili Street, Nanshan, Shenzhen, China
 Tel: 86-755-8355-1886 Fax: 86-755-8355-2533

 For detailed performance specs & shopping online see Yantel web site : www.yantel-corp.com