

Fixed Attenuator

- ◆ DC to 3.5 GHz
- ◆ 20 dB
- ◆ 100 Watt
- ◆ N Type

Features

- High Power
- High attenuation accuracy
- Small VSWR
- Low PIM

Model No. Description

FATXXXXXXXX

XXX- power handling:100W.

X- connector type: SMA, N type or
SMB connector.

XX- attenuation: **dB.

XX- 04 represents type number

AVERAGE POWER: 100W average to 25°C ambient temperature,
derated linearly to 10W @ 125°C.

PEAK POWER: 5KW (5µs pulse width with 1.0% duty cycle)

CONNECTOR TYPE: N, N male to N female bidirectional type

WEIGHT: about 0.8Kg

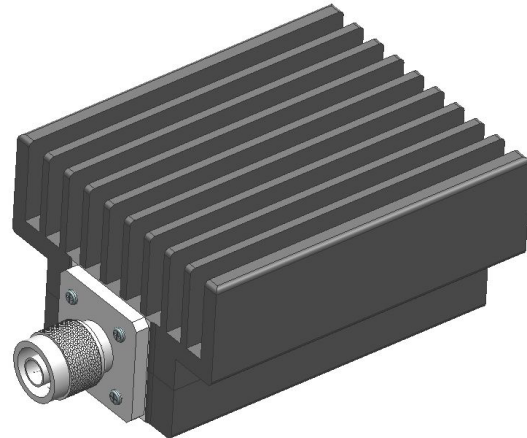

Specifications

Frequency Range	DC to 3.5 GHz
Attenuation	20 dB
Attenuation Accuracy	±0.75 dB over DC - 3 GHz ±1.0 dB over 3 – 3.5 GHz
Nominal Impedance	50 Ohm
Average Power	100 Watt
Operating Temperature	-55 °C to +125°C
Storage Temperature	-55 °C to +125°C

FREQ. RANGE (GHz)	Typical VSWR(:1)	Maximum VSWR(:1)
DC to 1	1.15	
1 to 2	1.25	
2 to 3.5	1.30	
DC to 3.5		1.35

Material & Plating

Parts	Material	Plating(Micro-inch)
Body & Nut	Aluminum	Black Anodize
Contact (female & male)	QSn6.5-0.1	Gold 30
Insulator	Teflon	

Yantel Corporation

Add: 3F, Building 3, Southern District 2 of Zhongguan Honghualing Industrial Park, Xili, Nanshan, Shenzhen, China

Tel: 86-755-8355-1886 Fax: 86-755-8355-2533

For detailed performance specs & shopping online see Yantel web site : www.yantel-corp.com

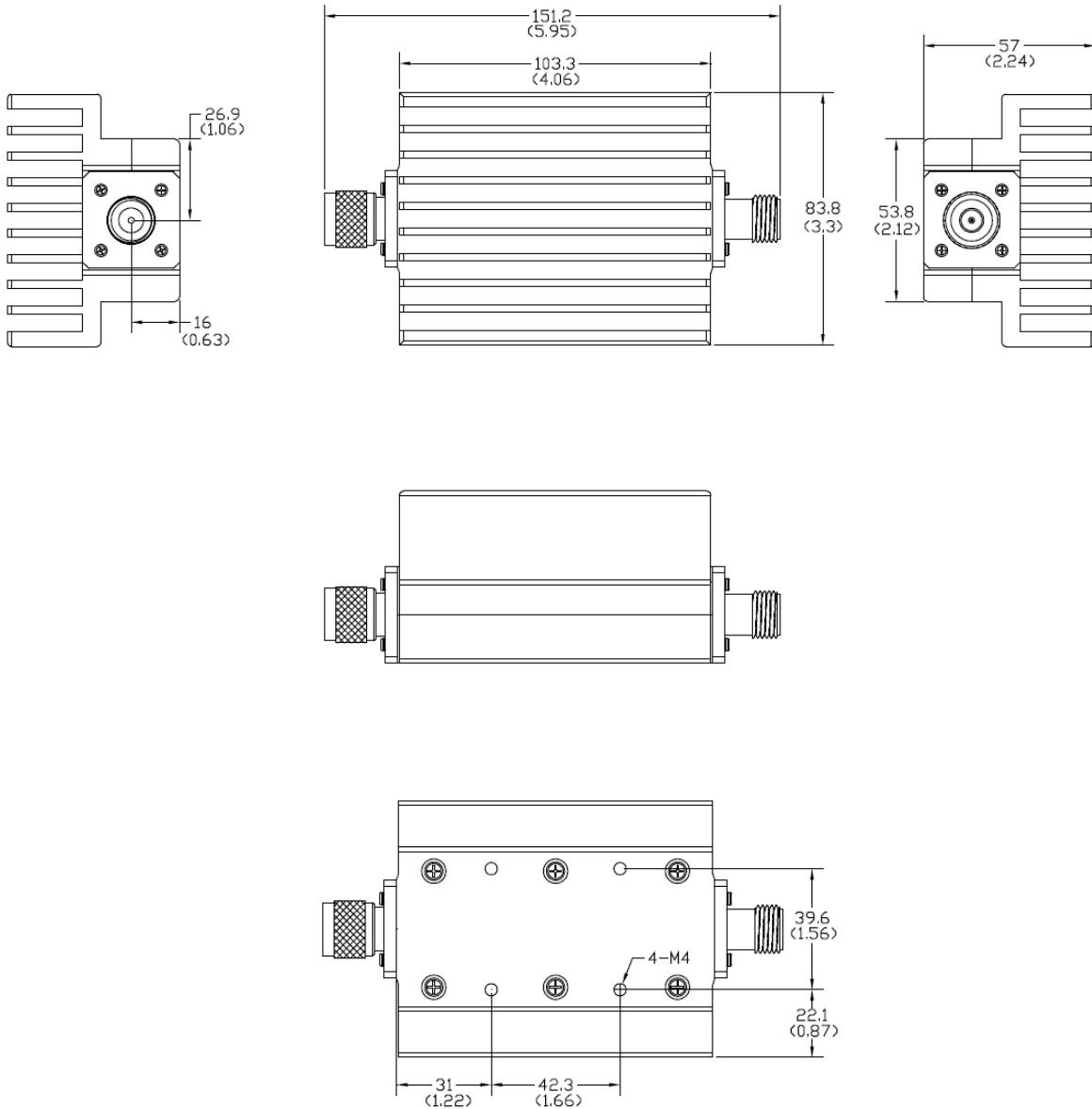
Package Outlines

Notes:

1. all dimensions shown in mm & inch
2. Dimensions Tolerance $\pm 2\%$
3. Dimensions and specifications refer to connector type N unless otherwise specified.
4. Custom designs available for other special attenuation value & accuracy

Yantel Corporation

 Add: 3F, Building 3, Southern District 2 of Zhongguan Honghualing Industrial Park, Xili, Nanshan, Shenzhen, China
 Tel: 86-755-8355-1886 Fax: 86-755-8355-2533

 For detailed performance specs & shopping online see Yantel web site : www.yantel-corp.com