

**Part No. Descriptions**

Part No.	Frequency Range Code	Attenuation (dB)	Temperature Coefficient Code	Temperature Coefficient of Attenuation (dB/dB/°C)	Typ. VSWR (:1) @25°C	Max. Input Power (mW)	Attenuation Accuracy (dB)
KTCA3602N**	16~36	2	N3~N7	-0.003~ -0.007	1.35	100	±1.0
KTCA3603N**	16~36	3	N3~N7	-0.003~ -0.007	1.35	100	±1.0
KTCA3604N**	16~36	4	N3~N7	-0.003~ -0.007	1.35	100	±1.0
KTCA3605N**	16~36	5	N3~N7	-0.003~ -0.007	1.35	100	±1.0
KTCA3606N**	16~36	6	N3~N7	-0.003~ -0.007	1.35	100	±1.0

**General Specifications**

- |  |  |
|--|--|
| 1. Frequency Range   | 28 to 31GHz  |
| 2. Attenuation   | 2dB  |
| 3. Attenuation Accuracy  | at 25°C ±1.0dB Typical                             |
| 4. VSWR  | at 25°C 1.35:1 Typical                             |
| 5. Nominal Impedance   | 50 Ohms  |
| 6. Power Rating  | 100 mW CW  |
| 7. Power Derating  | 100% @ 100°C<br>Derates to 0% @ 150°C              |
| 8. Operating Temperature   | -55°C to +150°C                                    |
| 9. Temperature Coefficient over Operating Temperature Range: See Table Above.                                  | Temperature Coefficient Tolerance: ±0.001dB/dB/°C. |
| 10. Substrate: Alumina (Al <sub>2</sub> O <sub>3</sub> )   |  |
| 11. Resistive material: Thick film   |  |
| 12. Terminal material: Thick film, Input, Output and front Ground all made by gold, Back Ground made by Pd/Ag. |  |
| 13. Protective Coating: Thick film (ethyl acetate)   |  |
| 14. Package Outline: See Sheet 3.  |  |
| 15. Workmanship: per MIL-PRF-55342.  |  |
| 16. RoHS Compliant.  |  |
| 17. Electrostatic Discharge Control: per MIL-STD-1686.   |  |

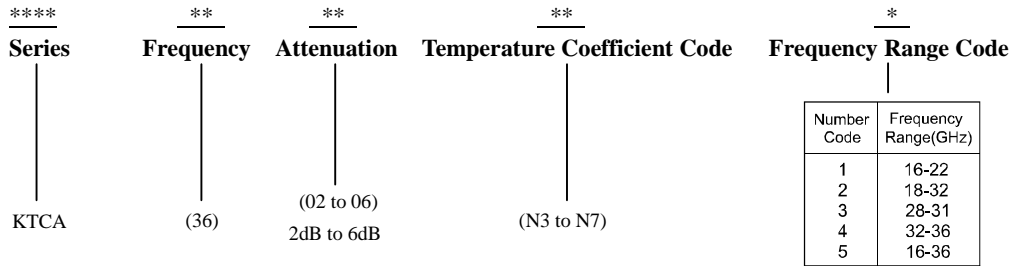
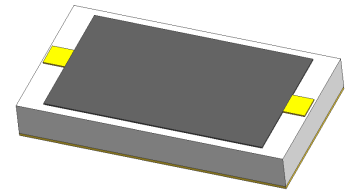

**Unit Marking**    dB Value (XX), Direction of Shift (N) and TCA Shift (X).  
 Legibility and Permanency: per MIL-STD-130.

**Quality Assurance**

1. Sample inspect per ANSI/ASQC Z1.4 general inspection, LEVEL II, AQL = 1.0.
  - 1.1 Visual and mechanical examination for conformance to outline package requirements.
2. Select five (5) Units from lot measure attenuation from 28 to 31GHz every 20°C over the temperature range -55°C to +125°C.
  - 2.1 Calculate, using linear regression, the slope of the curve.
  - 2.2 Calculate TCA using the following formula: TCA = Slope / Attenuation @ 25°C.
3. Test data required for customer.

**Yantel Corporation**

 Add: 3F, Building 3, Southern District 2 of Zhongguan Honghualing Industrial Park, Xili, Nanshan, Shenzhen, China  
 Tel: 86-755-8355-1886 Fax: 86-755-8355-2533

 For detailed performance specs & shopping online see Yantel web site : [www.yantel-corp.com](http://www.yantel-corp.com)

**Notes on RF Testing and Circuit Layout**

KTCA 16-36GHz series (for Gold Terminal type) Test Fixture

PCB Test Board

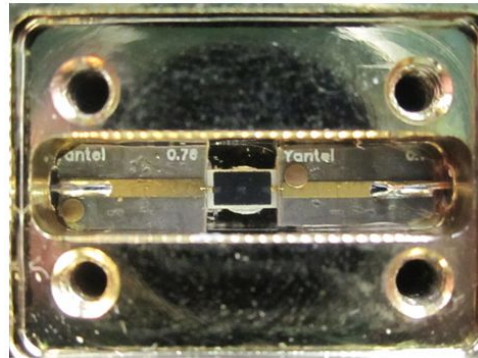
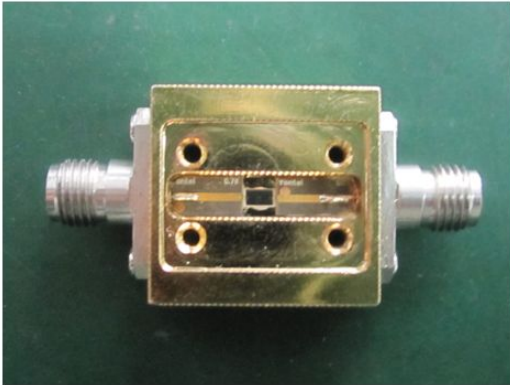

Connect test part to Test Fixture

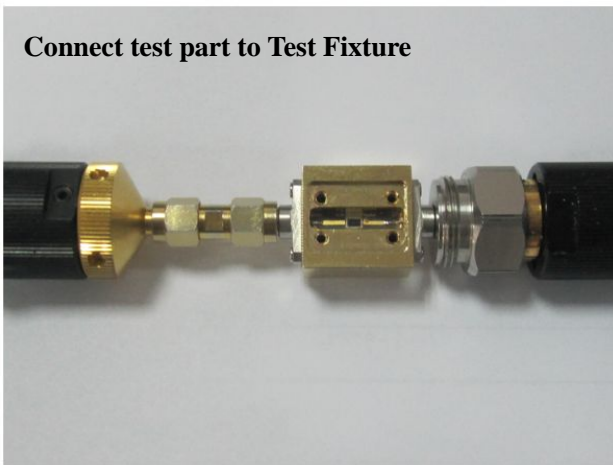

Equipment Calibration



Room Temperature Test

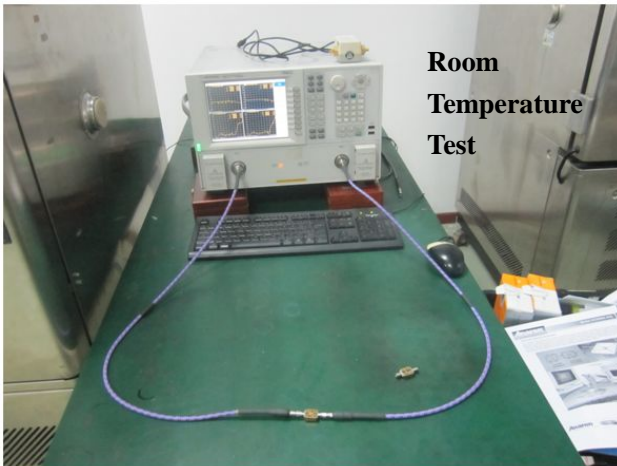

High-Low Temperature Test

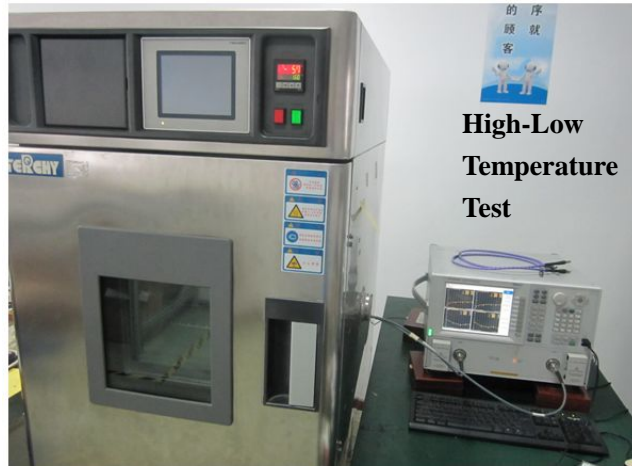

- 1、 S2P documents are available for download
- 2、 16-36GHz test fixture is rentable (only for Chinese customers) , otherwise please purchase them.

For any questions or needs, please feel free to contact [inform@yantel-corp.com](mailto:inform@yantel-corp.com).

**Package Outlines**

 All dimensions shown in mm unless stated otherwise  
 Note: Dimension tolerance in  $\pm 0.10$  otherwise mention.

Unit: mm

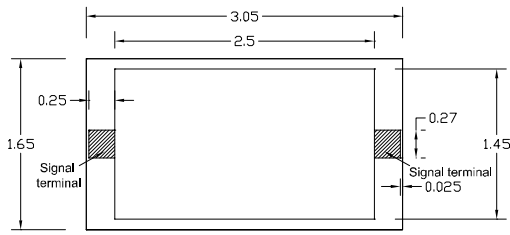
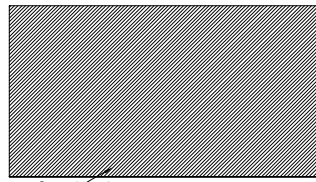
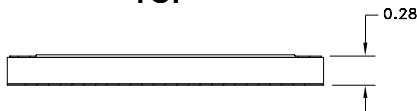

**TOP**

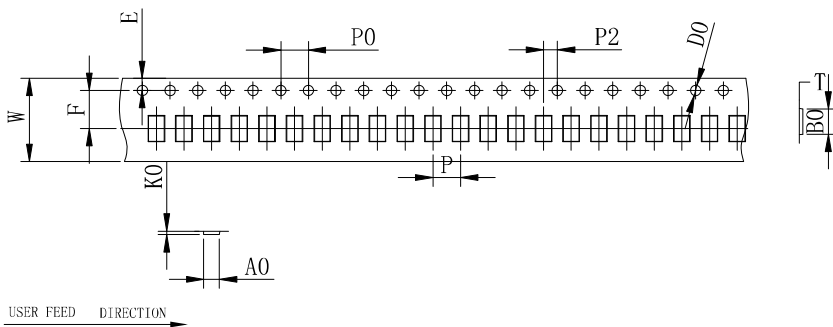
**BOTTOM**

**SIDE**
**Tape & Reel Drawing**

All dimensions shown in mm unless stated otherwise

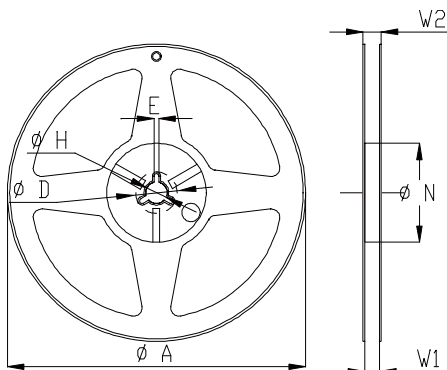

**Remarks:**

- 1>Total tolerance of any 10 sprocket holes is  $\leq \pm 0.20$ mm.
- 2>The thickness is measured on the margin of carrier tape.
- 3>Carrier camber should be not more than 1mm per 100mm through a length of 250mm.
- 4>The tolerance which is not marked is  $\pm 0.1$ mm
- 5>AO,BO are measured from 0.3mm above the bottom of the cavity. KO refers to the inside depth.
- 6>The angle R which is not marked on the cavity is 0.2-0.3.
- 7>Draft angle which is not marked is 3°.
- 8>25 m/reel; 6000 units (maximum) / T&R

symbol	A0	B0	K0	P0	P	P2
spec	$1.85 \pm 0.1$	$3.2 \pm 0.1$	$0.6 \pm 0.1$	$4.0 \pm 0.1$	$4.0 \pm 0.1$	$2.0 \pm 0.1$
symbol	W	T	E	F	D0	
spec	$12.0 \pm 0.3$	$0.3 \pm 0.05$	$1.75 \pm 0.1$	$5.5 \pm 0.1$	$\Phi 1.5^{+0.1}_{-0.0}$	

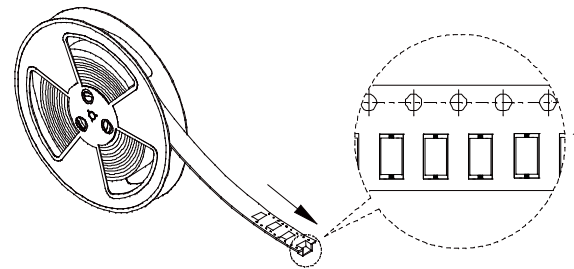

Symbol	Dimensions(mm)
A	$180^{+0/-3}$
N	$60^{+1/-0}$
W1	$12.0 \pm 0.3$
W2	$14 \pm 1.0$
D	$25 \pm 0.8$
H	$13 \pm 0.2$
E	$3 \pm 0.5$

**Yantel Corporation**

Add: 3F, Building 3, Southern District 2 of Zhongguan Honghualing Industrial Park, Xili, Nanshan, Shenzhen, China

Tel: 86-755-8355-1886 Fax: 86-755-8355-2533

 For detailed performance specs & shopping online see Yantel web site : [www.yantel-corp.com](http://www.yantel-corp.com)