

Part No. Descriptions

Part No.	Frequency Range Code	Attenuation (dB)	Temperature Coefficient Code	Temperature Coefficient of Attenuation (dB/dB/°C)	Typ. VSWR (:1) @25°C	Max. Input Power (mW)	Attenuation Accuracy (dB)
KTCA3602N**	16~36	2	N3~N7	-0.003~ -0.007	1.35	100	±1.0
KTCA3603N**	16~36	3	N3~N7	-0.003~ -0.007	1.35	100	±1.0
KTCA3604N**	16~36	4	N3~N7	-0.003~ -0.007	1.35	100	±1.0
KTCA3605N**	16~36	5	N3~N7	-0.003~ -0.007	1.35	100	±1.0
KTCA3606N**	16~36	6	N3~N7	-0.003~ -0.007	1.35	100	±1.0

General Specifications

1. Frequency Range 18 to 32GHz
2. Attenuation 5dB
3. Attenuation Accuracy at 25°C ±1.0dB Typical
4. VSWR at 25°C 1.35:1 Typical
5. Nominal Impedance 50 Ohms
6. Power Rating 100 mW CW
7. Power Derating 100% @ 100°C
Derates to 0% @ 150°C
8. Operating Temperature -55°C to +150°C
9. Temperature Coefficient over Operating Temperature Range: See Table Above.
Temperature Coefficient Tolerance: ±0.001dB/dB/°C.
10. Substrate: Alumina (Al₂O₃)
11. Resistive material: Thick film
12. Terminal material: Thick film, Input, Output and front Ground all made by gold, Back Ground made by Pd/Ag.
13. Protective Coating: Thick film (ethyl acetate)
14. Package Outline: See Sheet 3.
15. Workmanship: per MIL-PRF-55342.
16. RoHS Compliant.
17. Electrostatic Discharge Control: per MIL-STD-1686.

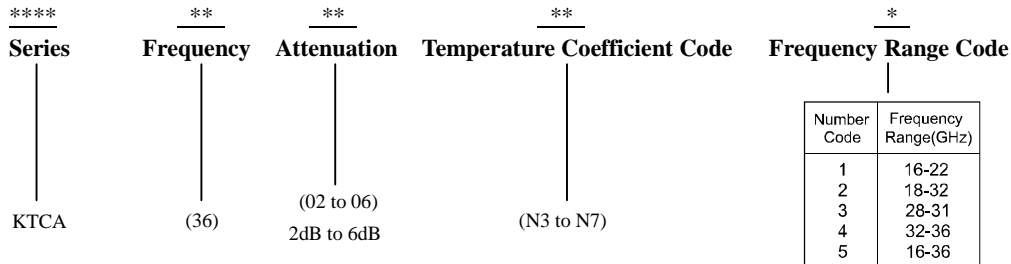
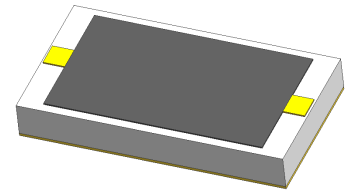

Unit Marking dB Value (XX), Direction of Shift (N) and TCA Shift (X).
Legibility and Permanency: per MIL-STD-130.

Quality Assurance

1. Sample inspect per ANSI/ASQC Z1.4 general inspection, LEVEL II, AQL = 1.0.
 - 1.1 Visual and mechanical examination for conformance to outline package requirements.
2. Select five (5) Units from lot measure attenuation from 18 to 32GHz every 20°C over the temperature range -55°C to +125°C.
 - 2.1 Calculate, using linear regression, the slope of the curve.
 - 2.2 Calculate TCA using the following formula: TCA = Slope / Attenuation @ 25°C.
3. Test data required for customer.

Yantel Corporation

Add: 3F, Building 3, Southern District 2 of Zhongguan Honghualing Industrial Park, Xili, Nanshan, Shenzhen, China
Tel: 86-755-8355-1886 Fax: 86-755-8355-2533

For detailed performance specs & shopping online see Yantel web site : www.yantel-corp.com

Notes on RF Testing and Circuit Layout

KTCA 16-36GHz series (for Gold Terminal type) Test Fixture

PCB Test Board

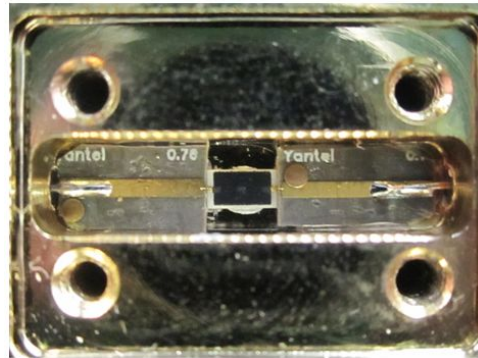
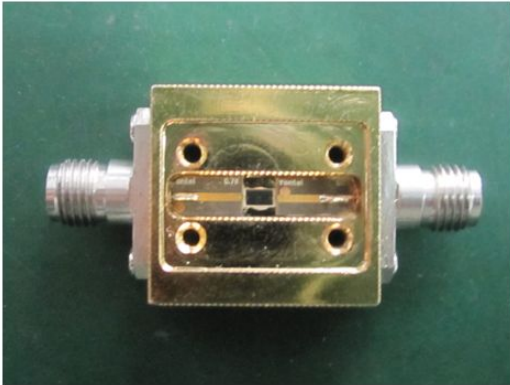

Connect test part to Test Fixture

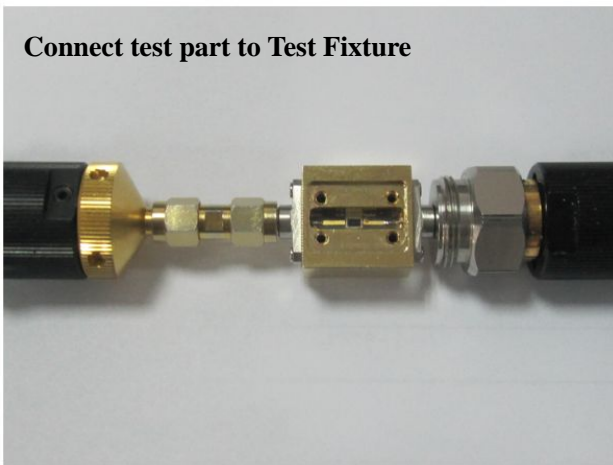

Equipment Calibration



Room Temperature Test

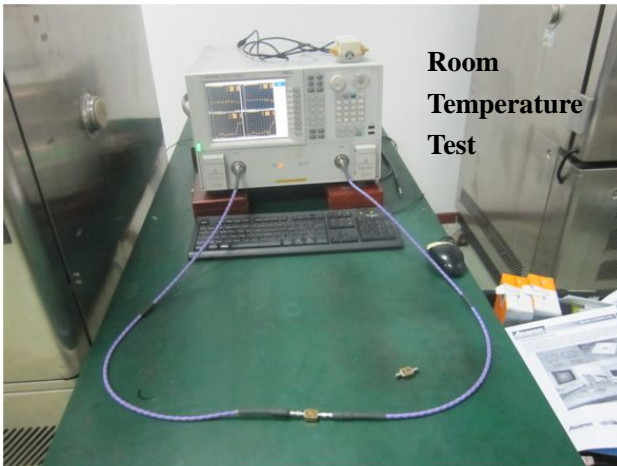

High-Low Temperature Test



- 1、 S2P documents are available for download
- 2、 16-36GHz test fixture is rentable (only for Chinese customers) , otherwise please purchase them.

For any questions or needs, please feel free to contact inform@yantel-corp.com.

Package Outlines

 All dimensions shown in mm unless stated otherwise
 Note: Dimension tolerance in ± 0.10 otherwise mention.

Unit: mm

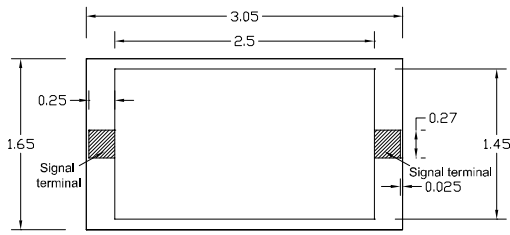
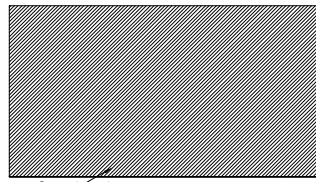
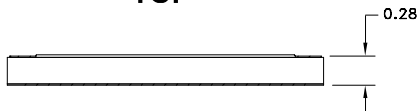

TOP

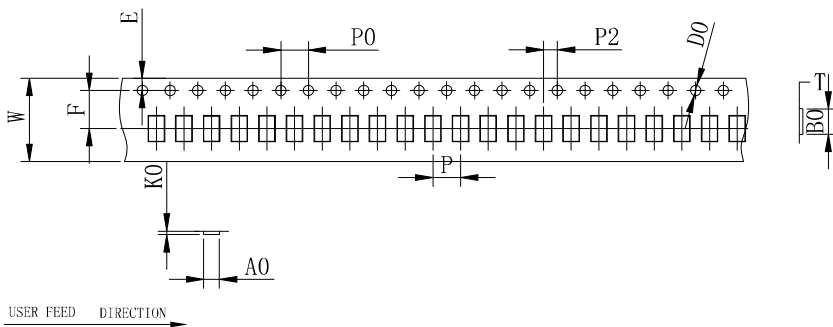
BOTTOM

SIDE
Tape & Reel Drawing

All dimensions shown in mm unless stated otherwise

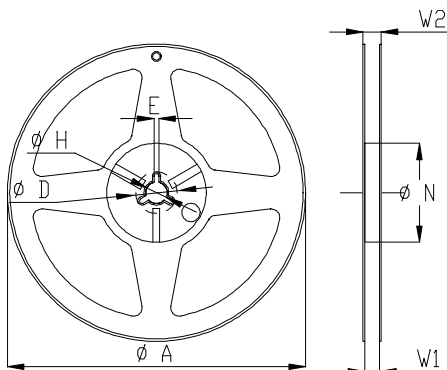

Remarks:

- 1>Total tolerance of any 10 sprocket holes is $\leq \pm 0.20$ mm.
- 2>The thickness is measured on the margin of carrier tape.
- 3>Carrier camber should be not more than 1mm per 100mm through a length of 250mm.
- 4>The tolerance which is not marked is ± 0.1 mm
- 5>AO,BO are measured from 0.3mm above the bottom of the cavity. KO refers to the inside depth.
- 6>The angle R which is not marked on the cavity is 0.2-0.3.
- 7>Draft angle which is not marked is 3°.
- 8>25 m/reel; 6000 units (maximum) / T&R

symbol	A0	B0	K0	P0	P	P2
spec	1.85 ± 0.1	3.2 ± 0.1	0.6 ± 0.1	4.0 ± 0.1	4.0 ± 0.1	2.0 ± 0.1
symbol	W	T	E	F	D0	
spec	12.0 ± 0.3	0.3 ± 0.05	1.75 ± 0.1	5.5 ± 0.1	$\Phi 1.5^{+0.1}_{-0.0}$	

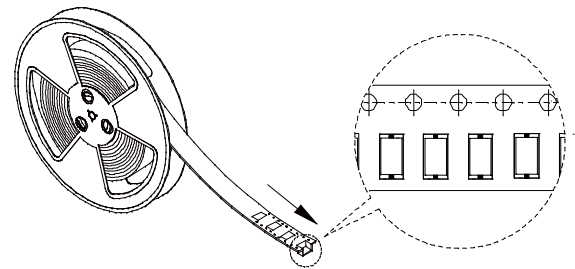

Symbol	Dimensions(mm)
A	$180^{+0/-3}$
N	$60^{+1/-0}$
W1	12.0 ± 0.3
W2	14 ± 1.0
D	25 ± 0.8
H	13 ± 0.2
E	3 ± 0.5

Yantel Corporation

Add: 3F, Building 3, Southern District 2 of Zhongguan Honghualing Industrial Park, Xili, Nanshan, Shenzhen, China

Tel: 86-755-8355-1886 Fax: 86-755-8355-2533

 For detailed performance specs & shopping online see Yantel web site : www.yantel-corp.com