

Description

The products are widely used in China and global 4G/5G base station, 5G network coverage, BeiDou navigation antenna, vehicle-mounted high-precision navigation (unmanned) antenna and other applications. The products have miniaturization, low-loss, wide-bandwidth, high power density, high reliability, high cost-effective and other competitive advantages.

Features:

- 2000-2300 MHz
- 0.7mm Height Profile
- Surface Mountable
- 4G/5G base station
- High Isolation & Low Loss
- Tape & Reel
- Non-conductive Surface
- RoHS Compliant
- Halogen-Free
- LTCC process

Electrical Specifications

Frequency	Isolation	Insertion Loss	VSWR
<i>MHz</i>	<i>dB Min</i>	<i>dB Max</i>	<i>Max : 1</i>
2000-2300	20	0.4	1.30
Amplitude Balance	Phase Balance	Power	Operating Temp.
<i>dB Max</i>	<i>Degrees</i>	<i>Avg. CW Watts at 105°C</i>	<i>°C</i>
± 0.40	90 ± 5.0	4	-55 to +105

Notes:

1. All the above data are based on specified demo board.
2. Insertion loss: Thru board loss has been removed.

Mechanical Outline

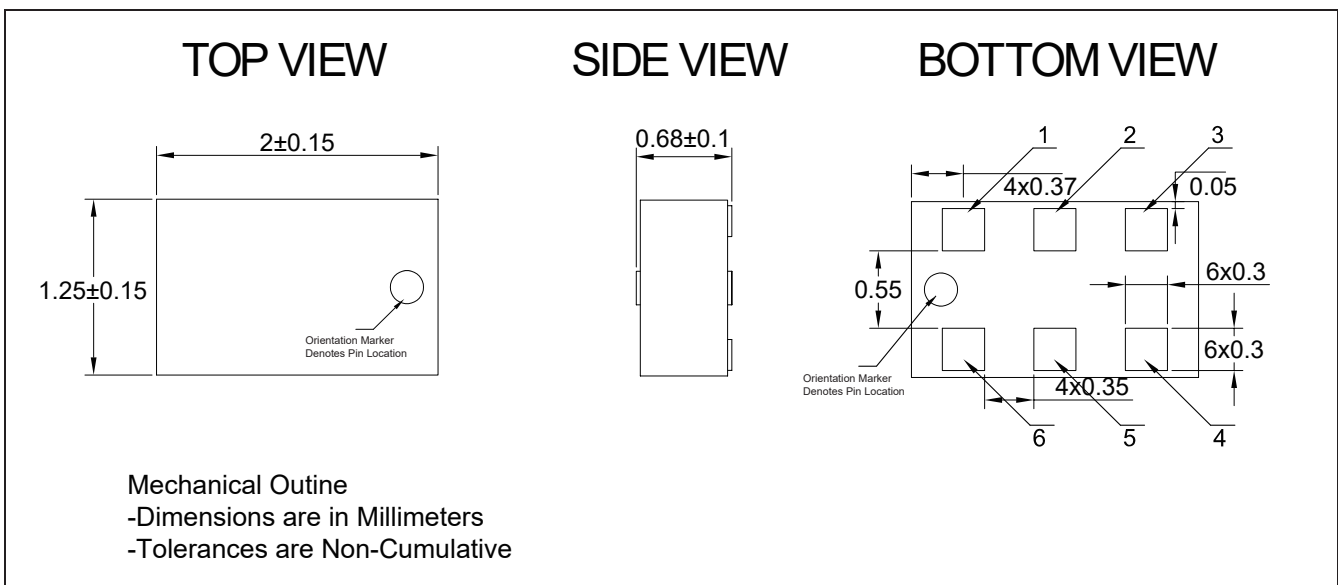

Yantel Corporation

Add: No.308-322, 3F, Building 1, Juchuang Jingu Innovation Park, Wenyuan Road 35, Xili Street, Nanshan, Shenzhen, China
 Tel: 86-755-8355-1886 Fax: 86-755-8355-2533

For detailed performance specs & shopping online see Yantel web site : www.yantel-corp.com

Hybrid Coupler Pin Configuration

The LHC21T03 has an orientation marker to denote Pin1. Once port one has been identified the other ports are known automatically. Please see the chart below for clarification:

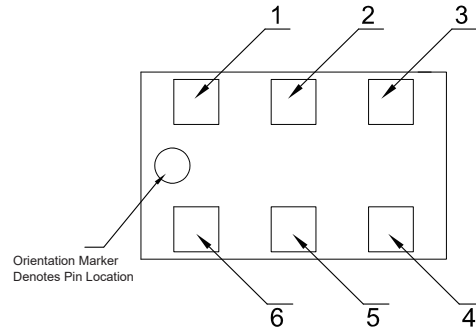

Pin	Configuration-1	Configuration-2	Configuration-3	Configuration-4
1	Input	Isolated	Direct	Coupled
2	GND	GND	GND	GND
3	Isolated	Input	Coupled	Direct
4	Direct	Coupled	Input	Isolated
5	GND	GND	GND	GND
6	Coupled	Direct	Isolated	Input

Typical Performance Data (@25°C)

Frequency (MHz)	Coupling (dB)	Transmission (dB)	Insertion Loss (dB)	Isolation (dB)	Amplitude Balance (dB)	Phase (degree)	Return Loss(dB)			
							S11	S22	S33	S44
2000	-3.39	-3.00	-0.24	-28.97	-0.14	-91.21	-24.63	-24.17	-24.92	-20.09
2015	-3.39	-2.99	-0.25	-28.89	-0.14	-91.24	-24.43	-24.14	-24.65	-19.92
2030	-3.40	-2.99	-0.25	-28.79	-0.14	-91.28	-24.32	-24.28	-24.46	-19.86
2045	-3.40	-2.99	-0.25	-28.72	-0.14	-91.33	-24.36	-24.36	-24.39	-19.93
2060	-3.41	-2.99	-0.25	-29.00	-0.14	-91.33	-24.25	-24.39	-24.40	-20.06
2075	-3.41	-2.99	-0.25	-29.35	-0.15	-91.35	-24.21	-24.14	-24.58	-20.00
2090	-3.42	-2.98	-0.25	-29.43	-0.15	-91.38	-24.38	-23.77	-24.77	-19.81
2105	-3.41	-2.97	-0.24	-29.34	-0.16	-91.43	-24.39	-23.34	-24.71	-19.56
2120	-3.41	-2.96	-0.24	-29.25	-0.16	-91.49	-24.17	-23.15	-24.43	-19.29
2135	-3.43	-2.96	-0.25	-29.06	-0.17	-91.54	-24.21	-23.08	-24.14	-19.23
2150	-3.44	-2.96	-0.25	-29.00	-0.18	-91.58	-24.19	-23.10	-23.98	-19.33
2165	-3.45	-2.96	-0.26	-29.11	-0.19	-91.60	-24.12	-23.02	-24.02	-19.47
2180	-3.47	-2.95	-0.26	-29.04	-0.20	-91.65	-24.11	-22.86	-24.19	-19.44
2195	-3.48	-2.94	-0.26	-28.99	-0.21	-91.71	-24.12	-22.46	-24.11	-19.20
2210	-3.49	-2.93	-0.26	-28.84	-0.22	-91.78	-24.00	-22.16	-23.91	-18.96
2225	-3.50	-2.92	-0.26	-28.57	-0.23	-91.83	-23.96	-22.06	-23.63	-18.74
2240	-3.50	-2.91	-0.26	-28.44	-0.24	-91.89	-23.79	-22.03	-23.30	-18.68
2255	-3.52	-2.90	-0.26	-28.39	-0.25	-91.92	-23.70	-22.09	-23.16	-18.69
2270	-3.54	-2.89	-0.27	-28.36	-0.26	-91.96	-23.73	-22.04	-23.16	-18.80
2285	-3.56	-2.88	-0.27	-28.33	-0.28	-92.04	-23.82	-21.76	-23.21	-18.74
2300	-3.58	-2.87	-0.27	-28.23	-0.29	-92.08	-23.90	-21.47	-23.15	-18.50

Yantel Corporation

Add: No.308-322, 3F, Building 1, Juchuang Jingu Innovation Park, Wenyuan Road 35, Xili Street, Nanshan, Shenzhen, China

Tel: 86-755-8355-1886 Fax: 86-755-8355-2533

For detailed performance specs & shopping online see Yantel web site : www.yantel-corp.com

Power Derating Curves

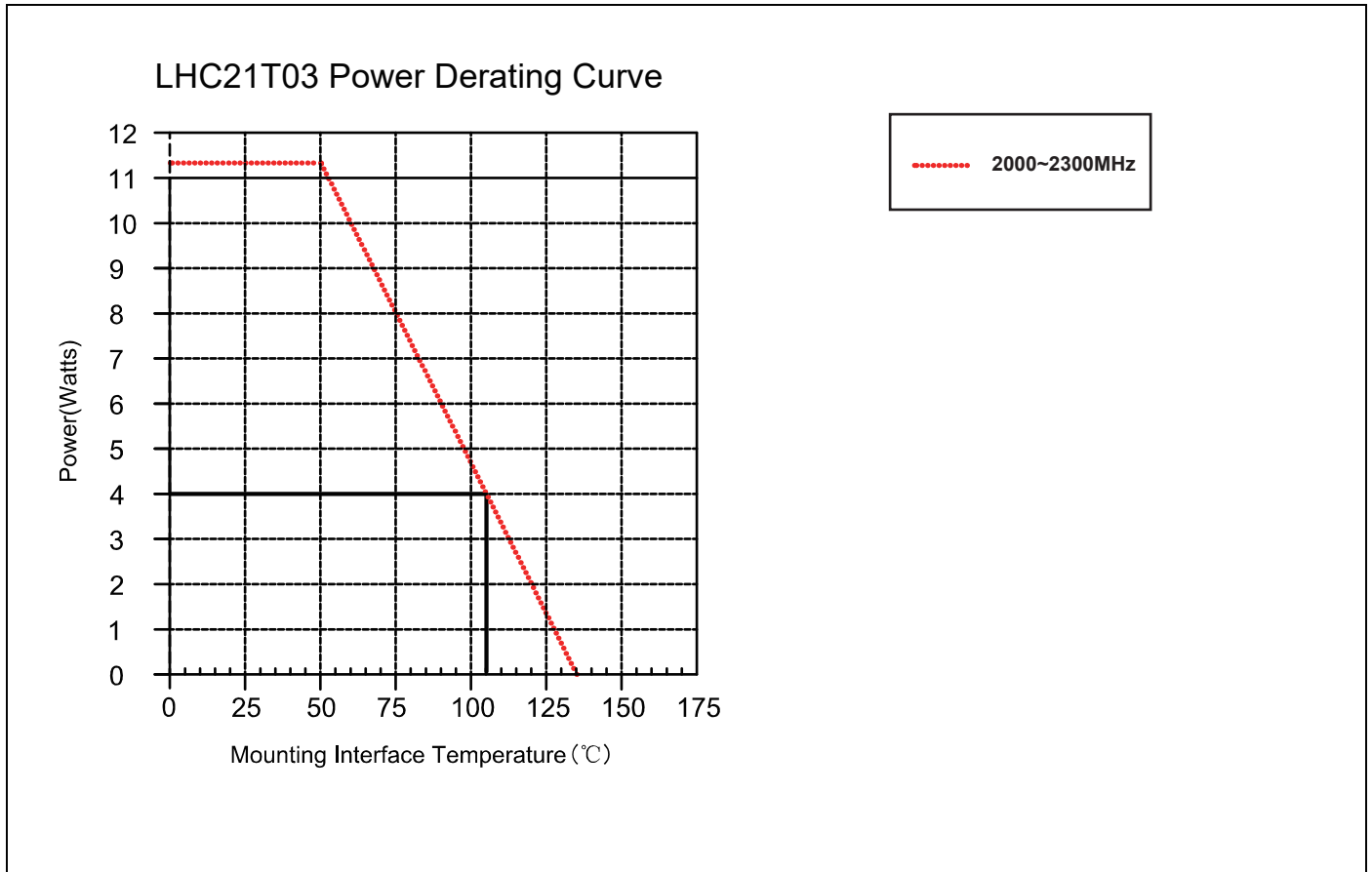

Power Derating:

As the mounting interface temperature approaches the maximum continuous operating temperature, the power handling decreases to zero.

Typical Performance (25°C: 2000-2300 MHz)

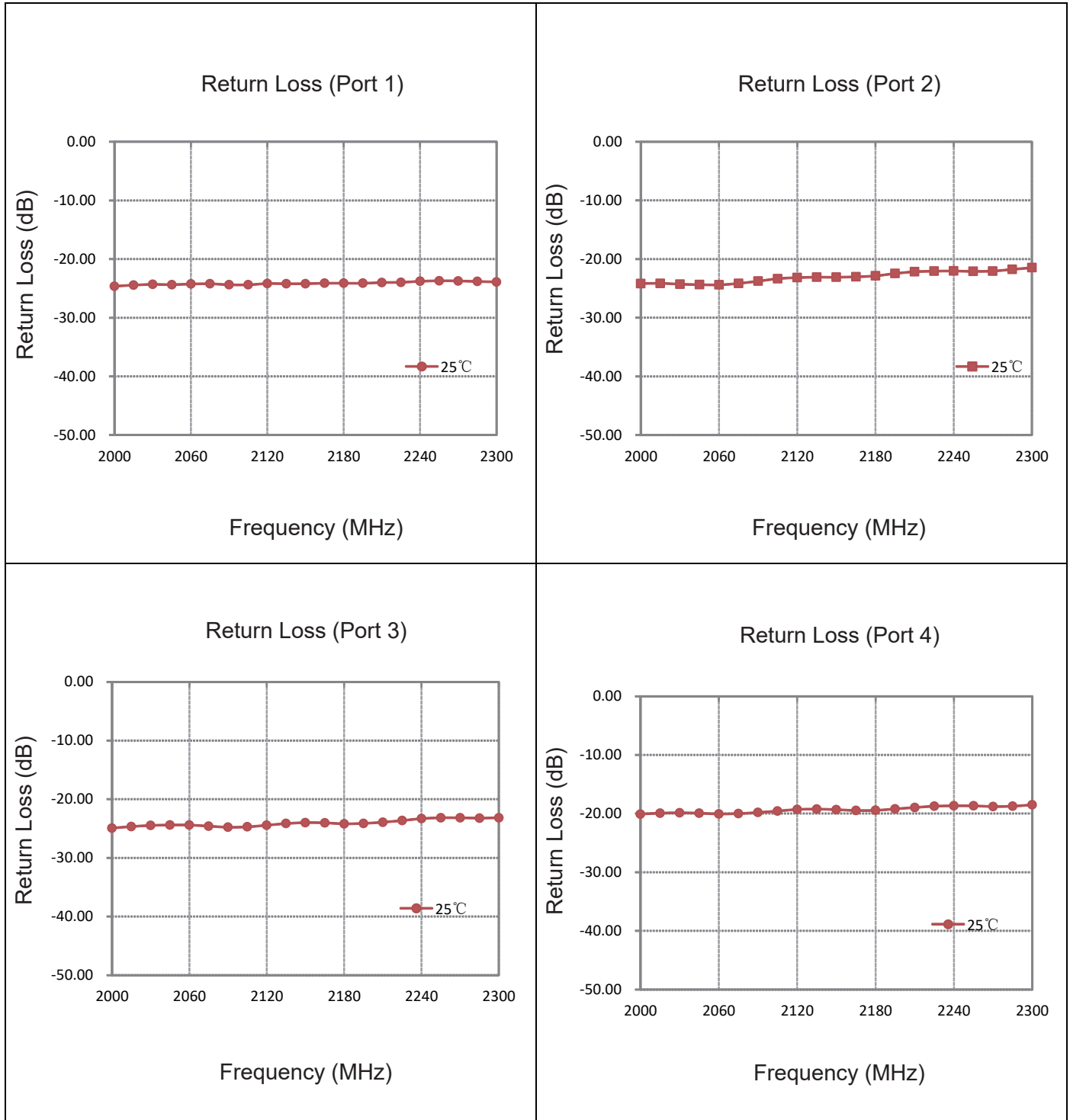

Yantel Corporation

Add: No.308-322, 3F, Building 1, Juchuang Jingu Innovation Park, Wenyuan Road 35, Xili Street, Nanshan, Shenzhen, China

Tel: 86-755-8355-1886 Fax: 86-755-8355-2533

 For detailed performance specs & shopping online see Yantel web site : www.yantel-corp.com

Typical Performance (25°C: 2000-2300 MHz)

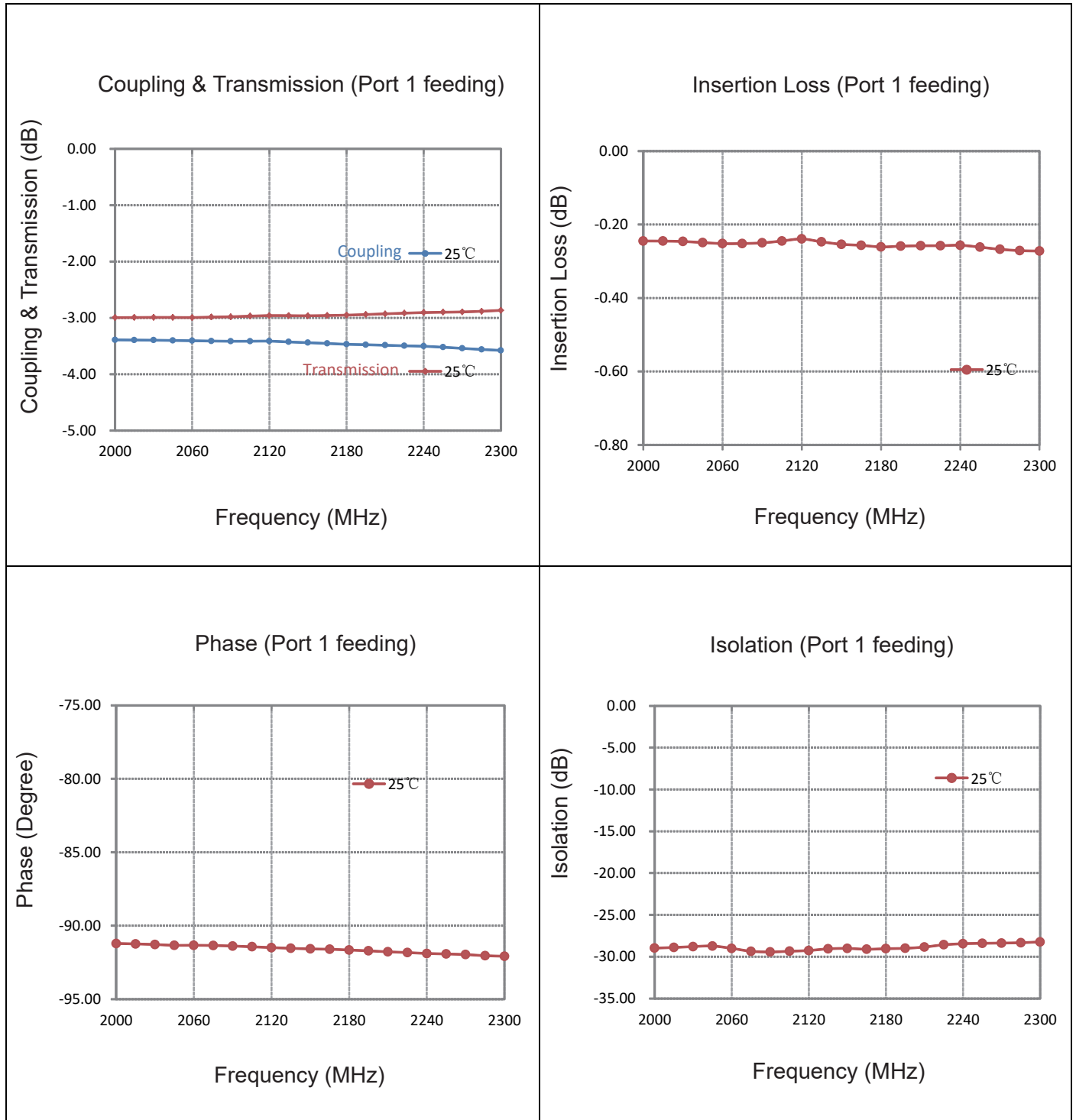

Yantel Corporation

Add: No.308-322, 3F, Building 1, Juchuang Jingu Innovation Park, Wenyuan Road 35, Xili Street, Nanshan, Shenzhen, China
 Tel: 86-755-8355-1886 Fax: 86-755-8355-2533

For detailed performance specs & shopping online see Yantel web site : www.yantel-corp.com

Definition of Measured Specifications

Parameter	Definition	Mathematical Representation
VSWR (Voltage Standing Wave Ratio)	The impedance match of the coupler to a 50Ω system. A VSWR of 1:1 is optimal.	$VSWR = \frac{V_{max}}{V_{min}}$ Vmax = voltage maxima of a standing wave Vmin = voltage minima of a standing wave
Return Loss	The impedance match of the coupler to a 50Ω system. Return Loss is an alternate means to express VSWR.	$\text{Return Loss (dB)} = 20 \log \frac{VSWR + 1}{VSWR - 1}$
Insertion Loss	The input power divided by the sum of the power at the two output ports.	$\text{Insertion Loss(dB)} = 10 \log \frac{P_{in}}{P_{cpl} + P_{transmission}}$
Isolation	The input power divided by the power at the isolated port.	$\text{Isolation(dB)} = 10 \log \frac{P_{in}}{P_{iso}}$
Phase Balance	The difference in phase angle between the two output ports.	Phase at coupled port – Phase at transmission port
Amplitude Balance	The power at each output divided by the average power of the two outputs.	$10 \log \frac{P_{cpl}}{\left(\frac{P_{cpl} + P_{transmission}}{2}\right)} \quad \text{or} \quad 10 \log \frac{P_{transmission}}{\left(\frac{P_{cpl} + P_{transmission}}{2}\right)}$

Test Method

1. Calibrating your vector network analyzer.
2. Connect the VNA 4 Port to DUT respectively.
3. Measure the data of coupling through port 1 to port 4(S41).
4. Measure the data of transmission through port 1 to port 3(S31).
5. Measure the data of isolation through port 1 to port 2(S21).
6. Measure the data of phase port 4 & port 3(port 1 feeding).
7. Measure the data of return loss port 1, port 2, port 3 & port 4.
8. According to the above data to calculate insertion loss, amplitude balance & phase.

Note:

1. When calculating insertion loss at room temperature, demo board loss should be removed from both coupling & transmission data. Please refer to the below table for demo board loss :

Frequency Range(MHz)	Demo Board Loss (dB) @25°C
470-860	0.07
800-1000	0.10
1200-1700	0.15
1700-2000	0.15
2000-2300	0.20
2300-2700	0.25

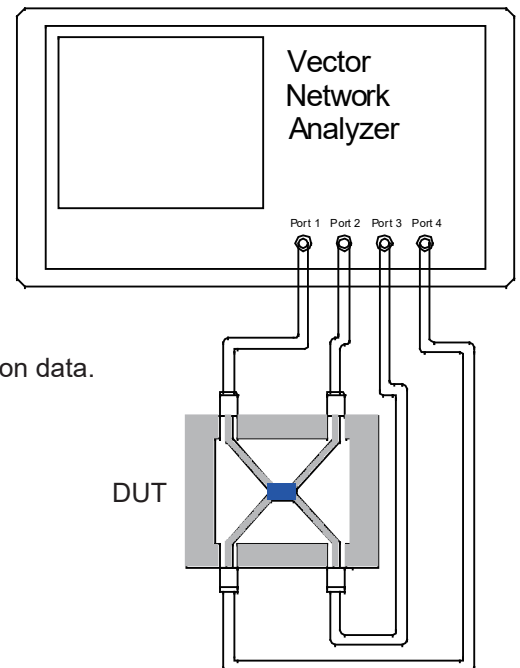

Recommended PCB Layout

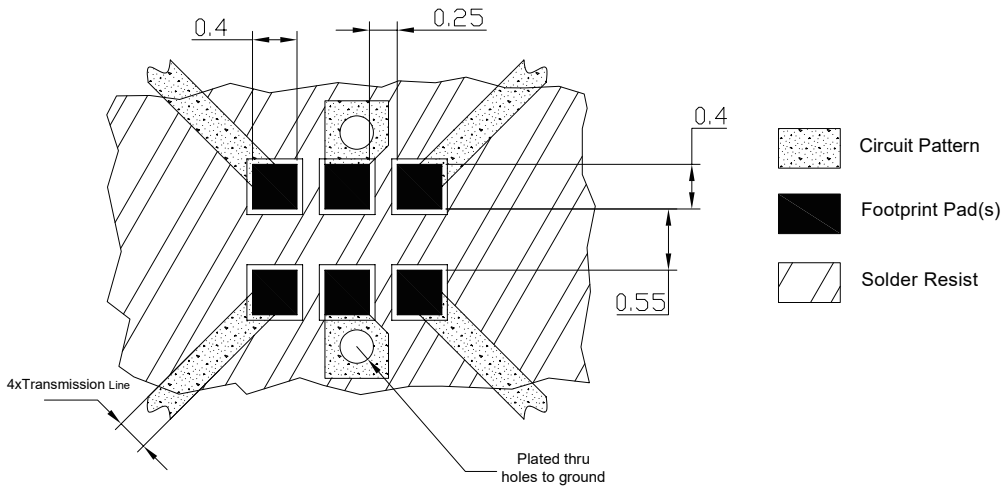

NOTE:

1. 50Ω line width is shown above designing.
2. Bottom side of the PCB is continuous ground plane.
3. All dimensions shown in mm [inch].

Reflow Profile

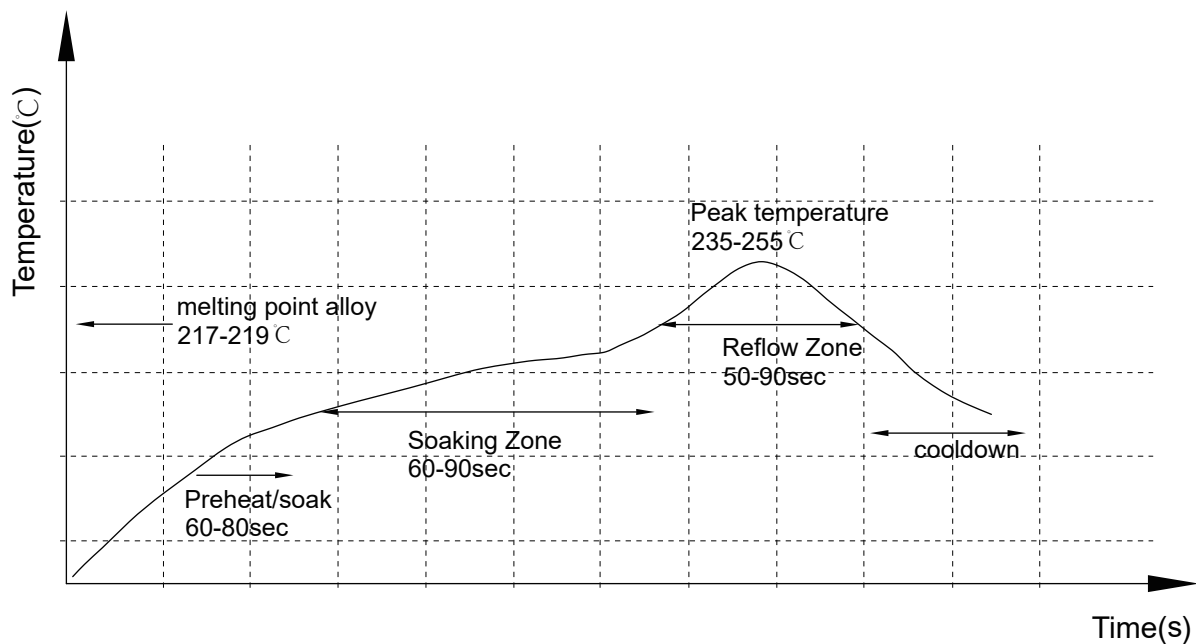

Yantel Corporation

Add: No.308-322, 3F, Building 1, Juchuang Jingu Innovation Park, Wenyuan Road 35, Xili Street, Nanshan, Shenzhen, China
 Tel: 86-755-8355-1886 Fax: 86-755-8355-2533

For detailed performance specs & shopping online see Yantel web site : www.yantel-corp.com

Reliability Test Flow

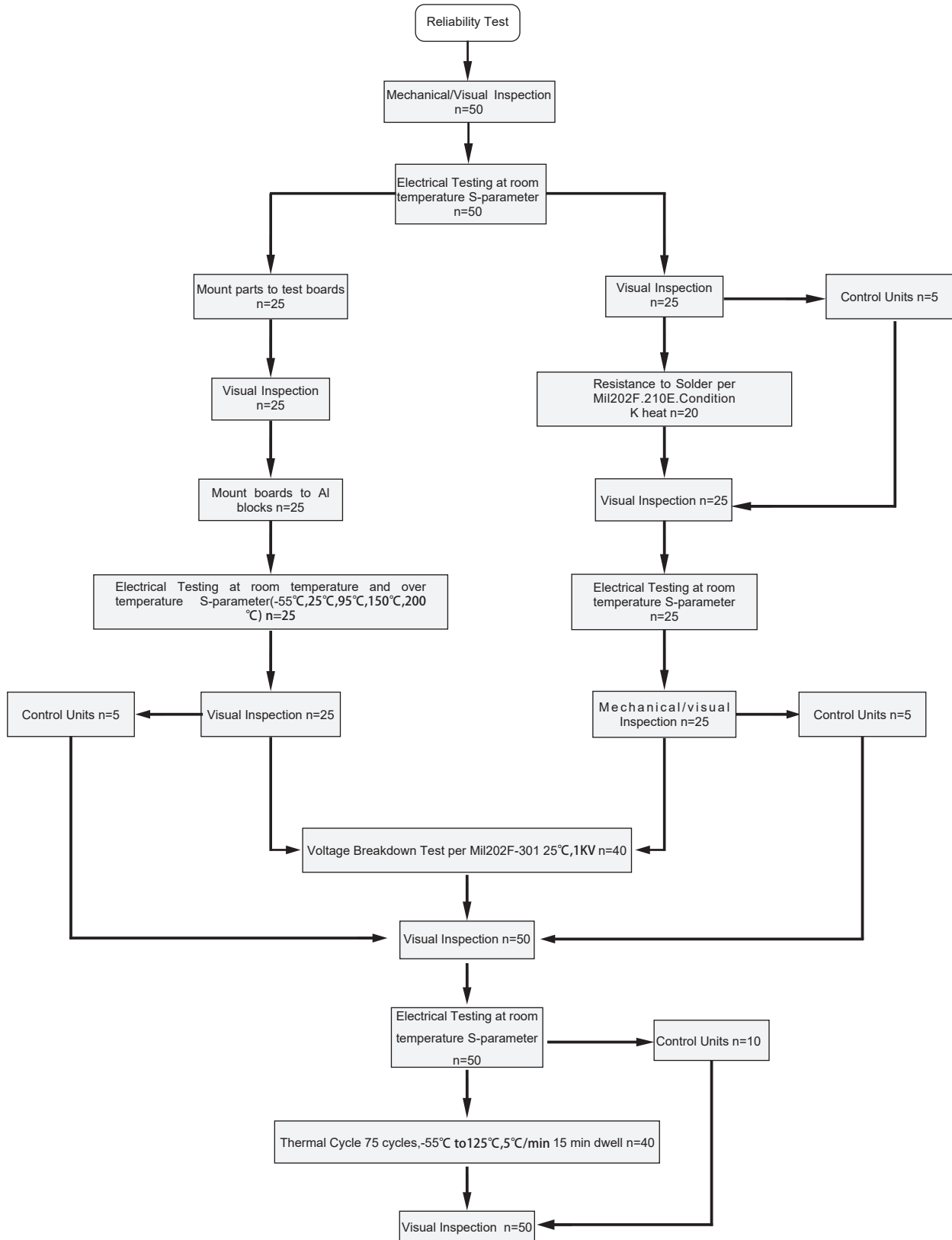

Reliability Test Flow

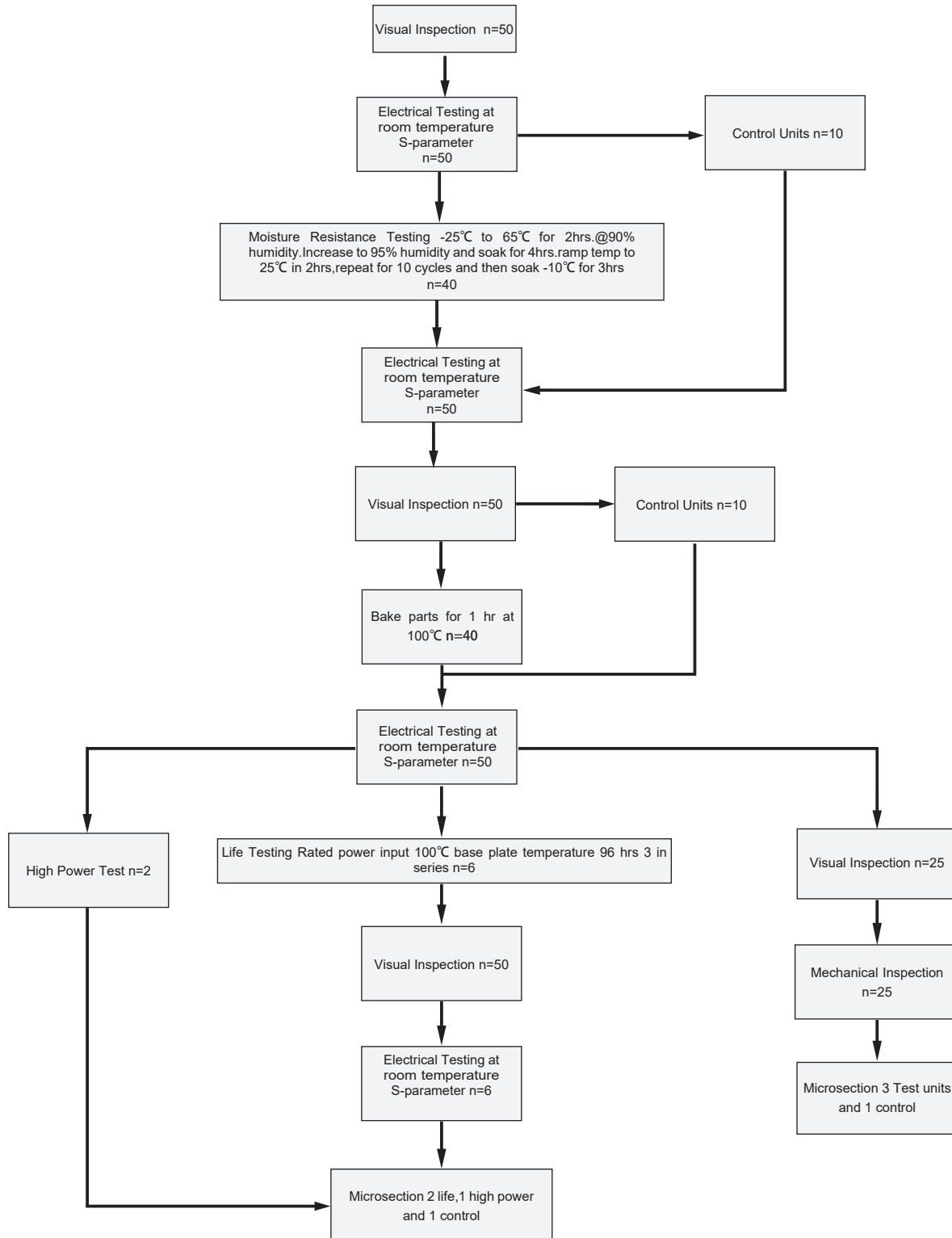

Tape and Reel Drawing

 Feeding Direction

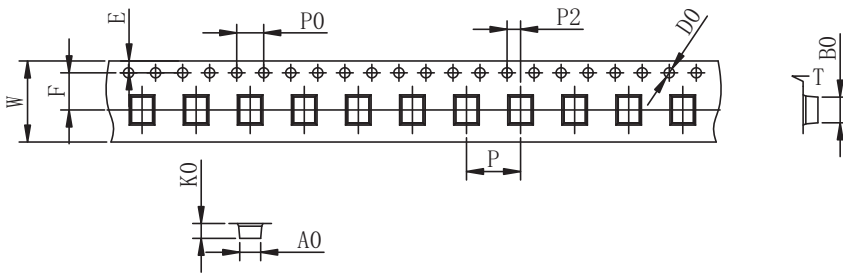
ITEM	W	A0	B0	K0	K1	P	F	E	D0	P0	P2	t	7"
DIM(mm)	8.0	1.45	2.30	1.00		4.0	3.5	1.75	1.5	4.0	2.0	0.2	P/R
TOLE	+0.10 -0.10	+0.10 -0.10	+0.10 -0.10	+0.10 -0.10	+0.10 -0.10	+0.10 -0.10	+0.10 -0.10	+0.10 -0.10	+0.10 -0.00	+0.10 -0.10	+0.10 -0.10	+0.05 -0.05	5000pcs

Notice:

- A. 10 Sprocket hole pitch cumulative tolerance is 0.2mm.
- B. Carrier camber shall be not more than 1mm per 100mm through a length of 250mm.
- C. All dimensions meet EIA-418-B requirements.
- D. A0 & B0 measured as indicated.
- E. K0 measured from a place on the inside bottom of the pocket to top surface of carrier.
- F. Material: PE 100
- G. Thickness: 0.20±0.05mm
- H. 5000 units (maximum) / T&R

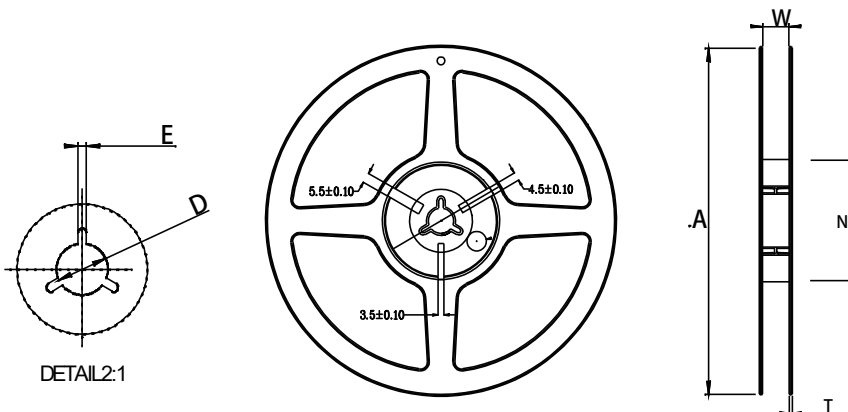

Symbol	Dimensions(mm)
W	9.0±0.4
A	180±0.3
N	60±0.3
T	1.4±0.2
E	3±0.5
D	25±0.8

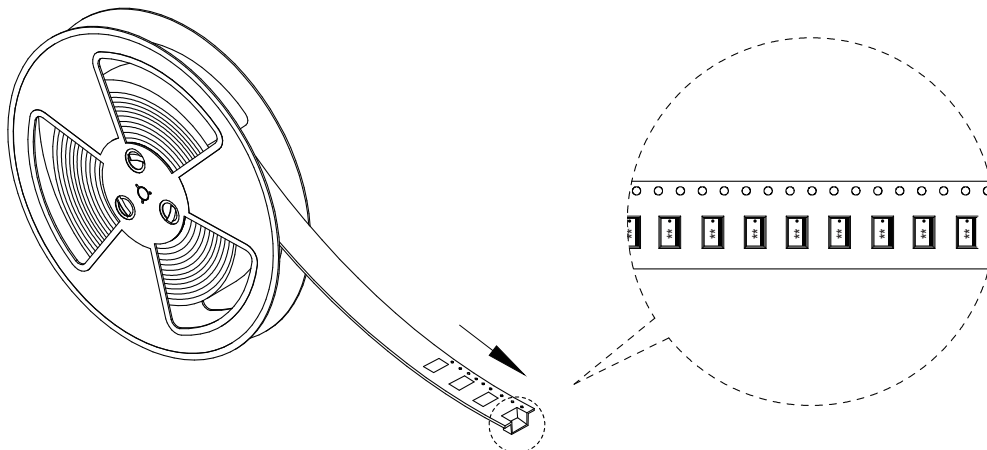

Yantel Corporation

Add: No.308-322, 3F, Building 1, Juchuang Jingu Innovation Park, Wenyuan Road 35, Xili Street, Nanshan, Shenzhen, China

Tel: 86-755-8355-1886 Fax: 86-755-8355-2533

 For detailed performance specs & shopping online see Yantel web site : www.yantel-corp.com