

Microwave Temperature Compensation Attenuator DC~18GHz 50Ω 200mW
Part No. Descriptions

****	**	**	**	**	**	*
Series	Frequency	Attenuation	Temperature Coefficient Code	Metallization Options	Termination	Plating Options
MTCA	18	(01 to 10) 1dB to 10dB	(N3 to N9)	Planar(no code), W1, W3, WB1 or G	(no code)=lead free or (S)=Lead(Pb)	

Metallization Options

- Planar(no code): planar terminal.
- Single wrap(W1): metallization wrap ground terminal.
- Triple wrap(W3): metallization wrap input, output and ground terminal.
- Wire bond(WB1): metallization wrap ground terminal, input and output terminal have gold metallization for wire bonding.
- Planar gold(G): planar terminal with gold metallization for wire bonding.

Part No.	Frequency Range (GHz)	Attenuation (dB)	Temperature Coefficient Code	Temperature Coefficient of Attenuation (dB/dB/°C)	Max. VSWR (:1) @1GHz@25°C	Max. Input Power (mW)	Attenuation Accuracy (dB)
MTCA1801N*W3	DC-12.4	1	N3~N7	-0.003~-0.007	1.20	200	±0.5
MTCA1802N*W3	DC-12.4	2	N3~N9	-0.003~-0.009	1.20	200	±0.5
MTCA1803N*W3	DC-12.4	3	N3~N9	-0.003~-0.009	1.20	200	±0.5
MTCA1804N*W3	DC-12.4	4	N3~N9	-0.003~-0.009	1.20	200	±0.5
MTCA1805N*W3	DC-12.4	5	N3~N9	-0.003~-0.009	1.20	200	±0.5
MTCA1806N*W3	DC-12.4	6	N3~N9	-0.003~-0.009	1.20	200	±0.5
MTCA1807N*W3	DC-12.4	7	N3~N9	-0.003~-0.009	1.20	200	±0.5
MTCA1808N*W3	DC-12.4	8	N3~N9	-0.003~-0.009	1.20	200	±0.5
MTCA1809N*W3	DC-12.4	9	N3~N9	-0.003~-0.009	1.20	200	±0.5
MTCA1810N*W3	DC-12.4	10	N3~N9	-0.003~-0.009	1.20	200	±0.5

General Specifications

1. Frequency Range WB3 series DC-12.4GHz
2. Attenuation 4dB
3. Attenuation Accuracy at 25°C ±0.5dB@1GHz
4. VSWR at 25°C 1.45:1 Max. over DC-12.4GHz
5. Nominal Impedance 50 Ohms
6. Power Rating 200 mW CW
7. Power Derating 100% @ 125°C
Derates to 0% @ 150°C
8. Operating Temperature -55°C to +150°C
9. Temperature Coefficient over Operating Temperature Range: See Table Above.
Temperature Coefficient Tolerance: ±0.001dB/dB/°C.
10. Substrate: Alumina (Al₂O₃)
11. Resistive material: Thick film
12. Terminal material: Thick film, Nickel barrier with pure tin plate (lead free) or with tin (Sn90) plate (10% lead contained), Or gold finish
13. Protective Coating: Thick film (ethyl acetate)
14. Package Outline: See Sheet 4.
15. Workmanship: per MIL-PRF-55342.
16. RoHS Compliant.
17. Electrostatic Discharge Control: per MIL-STD-1686.

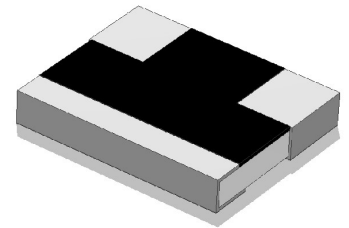

Unit Marking dB Value (XX), Direction of Shift (N) and TCA Shift (X).
Legibility and Permanency: per MIL-STD-130.

Quality Assurance

1. Sample inspect per ANSI/ASQC Z1.4 general inspection, LEVEL II, AQL = 1.0.
 - 1.1 Visual and mechanical examination for conformance to outline package requirements.
2. Select five (5) Units from lot measure attenuation from DC to 12.4GHz every 20°C over the temperature range -55°C to +125°C.
 - 2.1 Calculate, using linear regression, the slope of the curve.
 - 2.2 Calculate TCA using the following formula: TCA = Slope / Attenuation @ 25°C.
3. Test data required for customer.

Yantel Corporation

Add: 3F, Building 3, Southern District 2 of Zhongguan Honghualing Industrial Park, Xili, Nanshan, Shenzhen, China
Tel: 86-755-8355-1886 Fax: 86-755-8355-2533

For detailed performance specs & shopping online see Yantel web site : www.yantel-corp.com

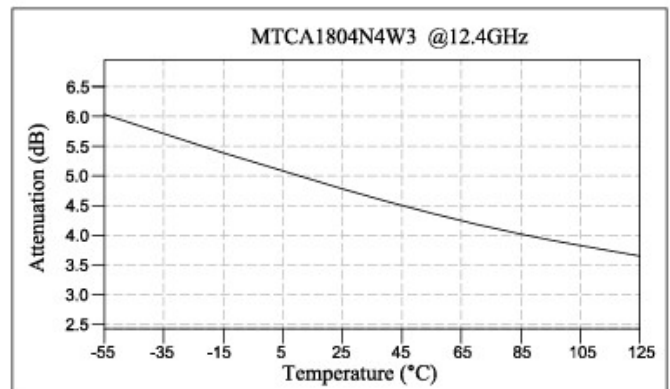
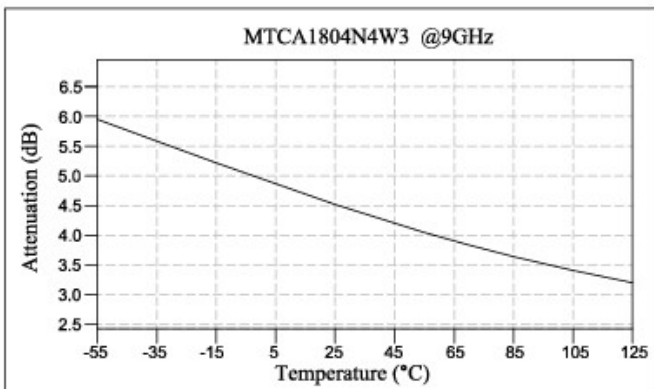
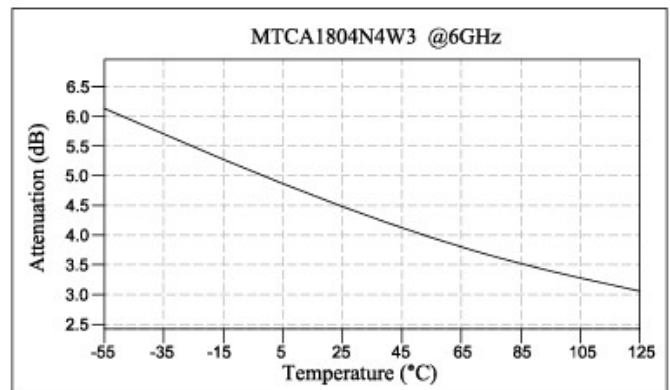
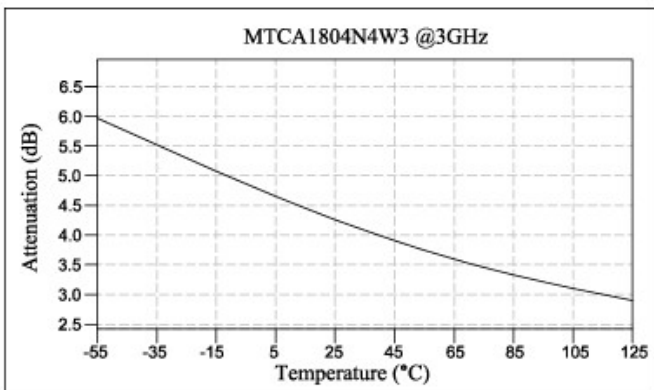
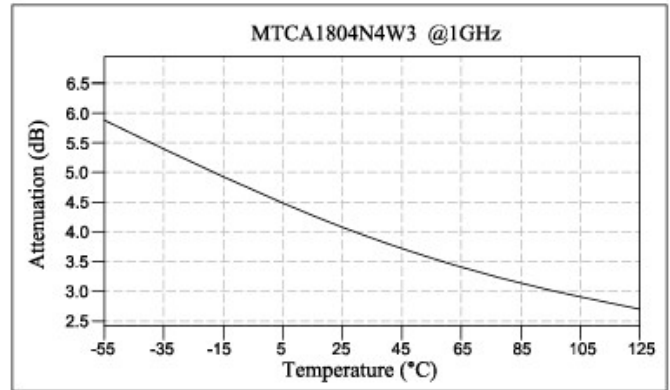
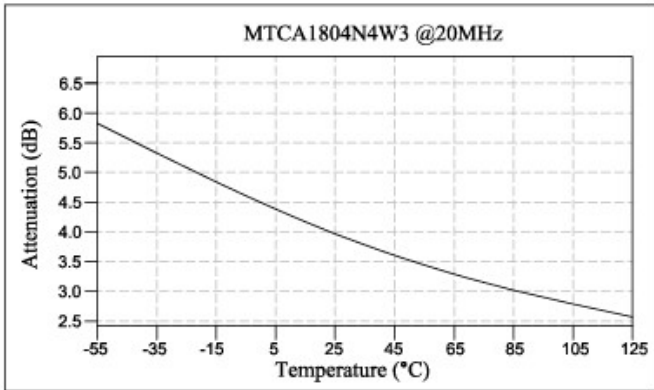
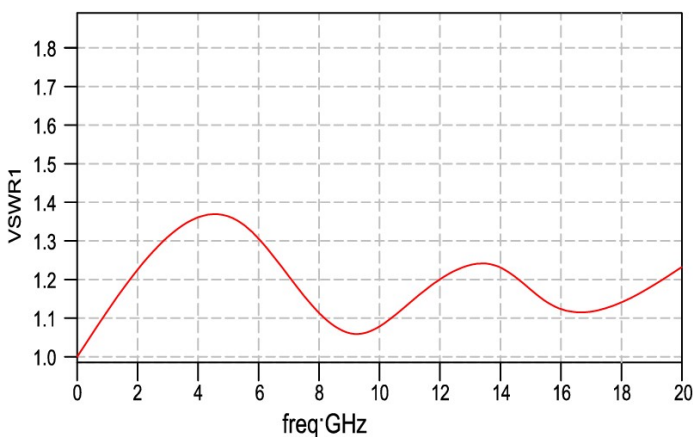
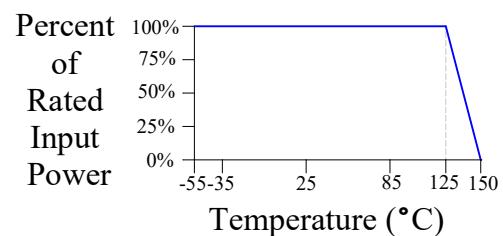
MTCA Response

Typical VSWR @25°C

Power Rating & Derating Curve

Notes on RF Testing and Circuit Layout

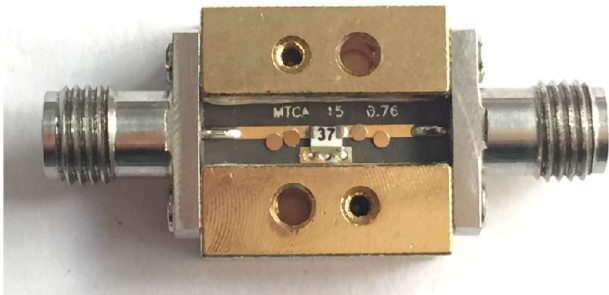
DC-12.4GHz W3 series(for SMT type) Test Fixture

SMT PCB Test Board



Connect test part to Test Fixture

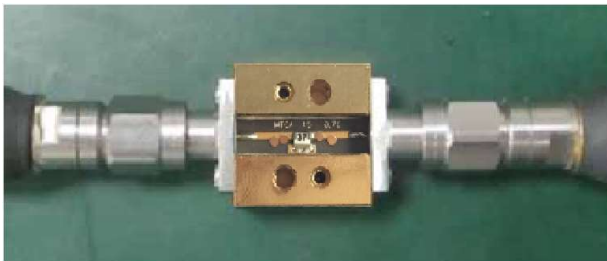

Equipment Calibration

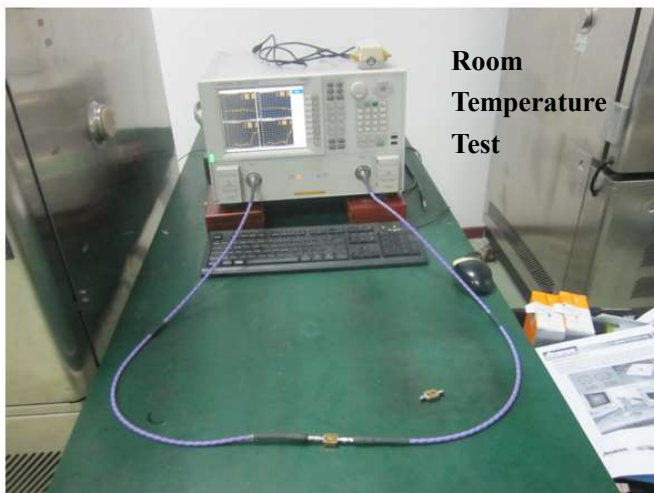

Room
Temperature
Test



High-Low
Temperature
Test

- 1、 S2P documents are available for download
- 2、 DC-18GHz or 16-36GHz test fixture is rentable (only for Chinese customers) , otherwise please purchase them.

For any questions or needs, please feel free to contact inform@yantel-corp.com

Package Outlines

All dimensions shown in mm unless stated otherwise

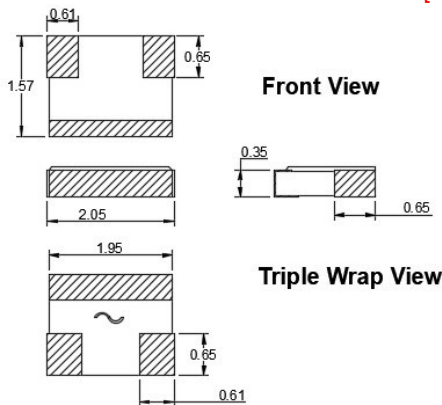
 Dimension tolerance: $\pm 0.1\text{mm}$ Unit: mm[inch]

Recommended Layout

All dimensions shown in mm unless stated otherwise

Unit: mm[inch]

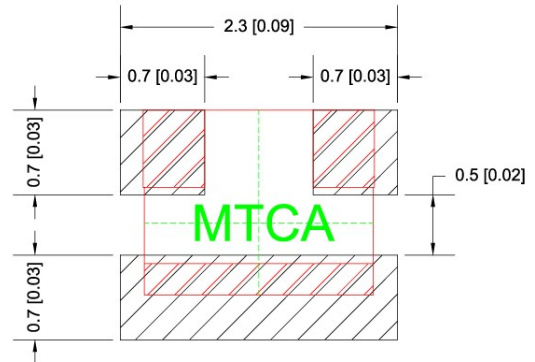

Tape & Reel Drawing

All dimensions shown in mm unless stated otherwise

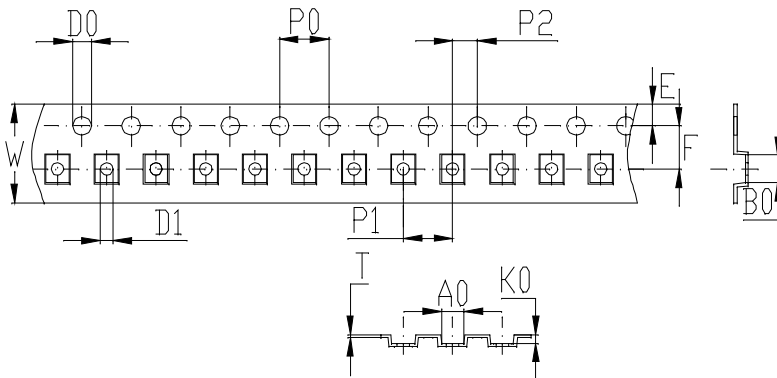

Notice:

- A.10 Sprocket hole pitch cumulative tolerance is 0.2mm.
- B. Carrier camber shall be not more than 1mm per 100mm through a length of 250mm.
- C. All dimensions meet EIA-418-B requirements.
- D. A0 & B0 measured as indicated.
- E. K0 measured from a place on the inside bottom of the pocket to top surface of carrier.
- F. Material: PS
- G. Thickness: $0.25 \pm 0.05\text{mm}$
- H. 5000 units (maximum) / T&R

symbol	A0	B0	K0	P0	P1	P2
spec	1.85 ± 0.1	2.25 ± 0.1	0.7 ± 0.1	4.0 ± 0.1	4.0 ± 0.1	2.0 ± 0.1
symbol	W	T	E	F	D0	D1
spec	8.0 ± 0.3	0.25 ± 0.05	1.75 ± 0.1	3.5 ± 0.1	$\Phi 1.5^{+0.1}_{-0.0}$	$\Phi 1.0^{+0.1}_{-0.0}$

