

**Microwave Temperature Compensation Attenuator DC~18GHz 50Ω 200mW**

**** Series	** Frequency	** Attenuation	** Temperature Coefficient Code	** Metallization Options	* Termination Plating Options
MTCA	18	(01 to 10) 1dB to 10dB	(N3 to N9)	Planar(no code), W1, W3, WB1 or G	(no code)=lead free or (S)=Lead(Pb)

**Metallization Options**

- Planar(no code): planar terminal.
- Single wrap(W1): metallization wrap ground terminal.
- Triple wrap(W3): metallization wrap input, output and ground terminal.
- Wire bond(WB1): metallization wrap ground terminal, input and output terminal have gold metallization for wire bonding.
- Planar gold(G): planar terminal with gold metallization for wire bonding.

Part No.	Frequency Range (GHz)	Attenuation (dB)	Temperature Coefficient Code	Temperature Coefficient of Attenuation (dB/dB/°C)	Max. VSWR (:1) @1GHz@25°C	Max. Input Power (mW)	Attenuation Accuracy (dB)
MTCA1801N*	DC-18	1	N3~N7	-0.003~ -0.007	1.20	200	±0.5
MTCA1802N*	DC-18	2	N3~N9	-0.003~ -0.009	1.20	200	±0.5
MTCA1803N*	DC-18	3	N3~N9	-0.003~ -0.009	1.20	200	±0.5
MTCA1804N*	DC-18	4	N3~N9	-0.003~ -0.009	1.20	200	±0.5
MTCA1805N*	DC-18	5	N3~N9	-0.003~ -0.009	1.20	200	±0.5
MTCA1806N*	DC-18	6	N3~N9	-0.003~ -0.009	1.20	200	±0.5
MTCA1807N*	DC-18	7	N3~N9	-0.003~ -0.009	1.20	200	±0.5
MTCA1808N*	DC-18	8	N3~N9	-0.003~ -0.009	1.20	200	±0.5
MTCA1809N*	DC-18	9	N3~N9	-0.003~ -0.009	1.20	200	±0.5
MTCA1810N*	DC-18	10	N3~N9	-0.003~ -0.009	1.20	200	±0.5

**General Specifications**

- Frequency Range  
Planar series DC-18GHz(N3~N5); DC-12.4GHz(N6~N9)
- Attenuation  
6dB
- Attenuation Accuracy  
at 25°C ±0.5dB@1GHz
- VSWR  
at 25°C 1.55:1 Max. over DC-18GHz
- Nominal Impedance  
50 Ohms
- Power Rating  
200 mW CW
- Power Derating  
100% @ 125°C  
Derates to 0% @ 150°C
- Operating Temperature  
-55°C to +150°C
- Temperature Coefficient over Operating Temperature Range: See Table Above.  
Temperature Coefficient Tolerance: ±0.001dB/dB/°C.
- Substrate: Alumina (Al<sub>2</sub>O<sub>3</sub>)
- Resistive material: Thick film
- Terminal material: Thick film, Nickel barrier with pure tin plate (lead free) or with tin (Sn90) plate (10% lead contained), or gold finish.
- Protective Coating: Thick film (ethyl acetate)
- Package Outline: See Sheet 4.
- Workmanship: per MIL-PRF-55342.
- RoHS Compliant.
- Electrostatic Discharge Control: per MIL-STD-1686.

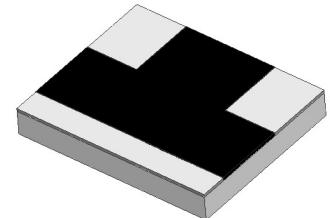

**Unit Marking** dB Value (XX), Direction of Shift (N) and TCA Shift (X).  
Legibility and Permanency: per MIL-STD-130.

**Quality Assurance**

- Sample inspect per ANSI/ASQC Z1.4 general inspection, LEVEL II, AQL = 1.0.
  - 1.1 Visual and mechanical examination for conformance to outline package requirements.
- Select five (5) Units from lot measure attenuation from DC to 18GHz every 20°C over the temperature range -55°C to +125°C.
  - 2.1 Calculate, using linear regression, the slope of the curve.
  - 2.2 Calculate TCA using the following formula: TCA = Slope / Attenuation @ 25°C.
- Test data required for customer.

**Yantel Corporation**

Add: 3F, Building 3, Southern District 2 of Zhongguan Honghualing Industrial Park, Xili, Nanshan, Shenzhen, China  
Tel: 86-755-8355-1886 Fax: 86-755-8355-2533

For detailed performance specs & shopping online see Yantel web site : [www.yantel-corp.com](http://www.yantel-corp.com)

MTCA Response

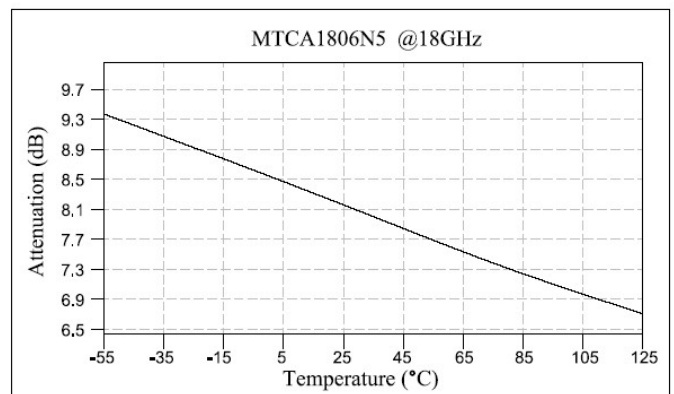
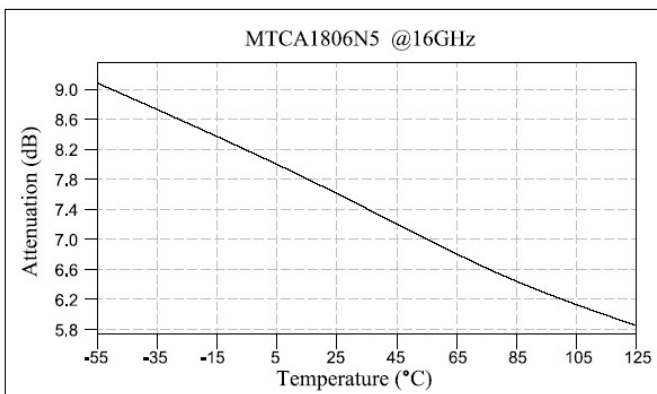
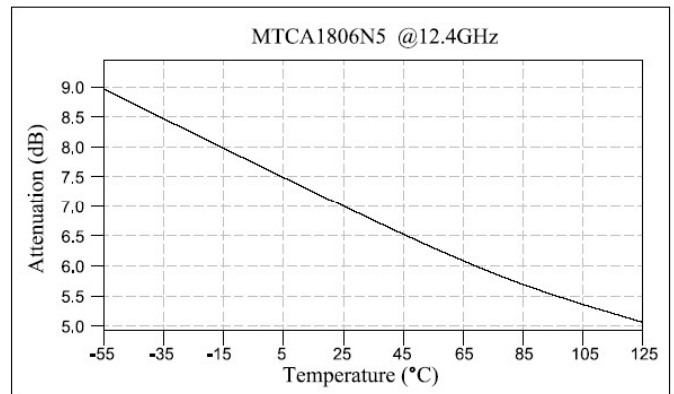
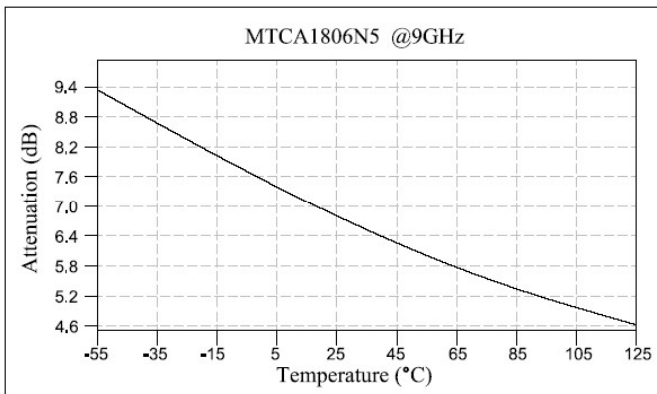
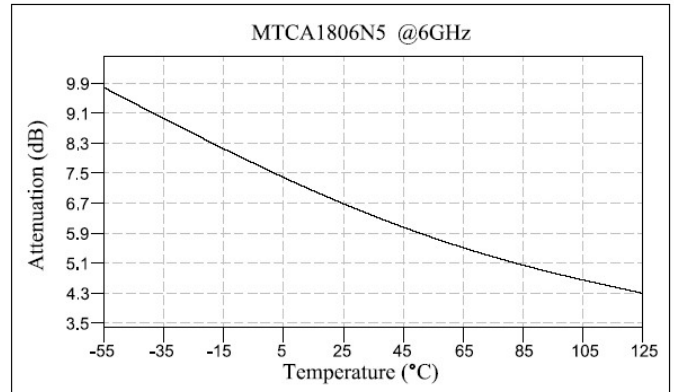
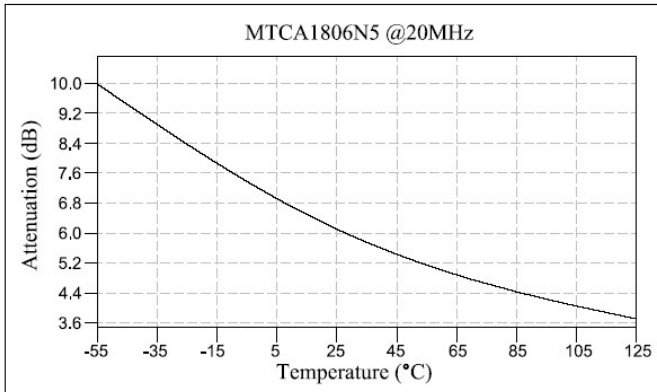

Typical VSWR @25°C

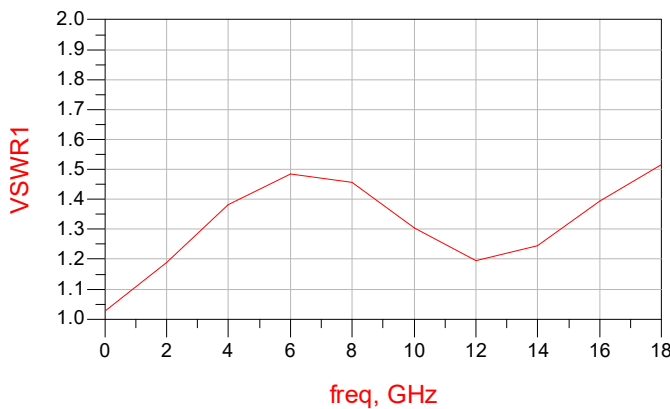

Power Rating & Derating Curve

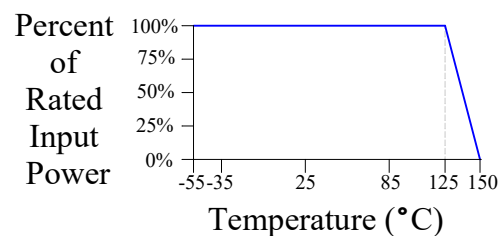

**Notes on RF Testing and Circuit Layout**

**DC-18GHz Planar series(for SMT type) Test Fixture**



**SMT PCB Test Board**

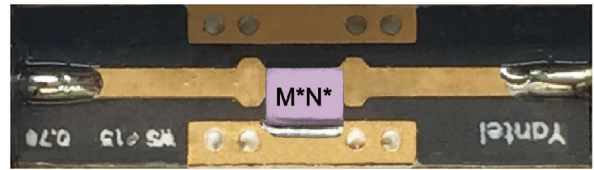

**Connect test part to Test Fixture**

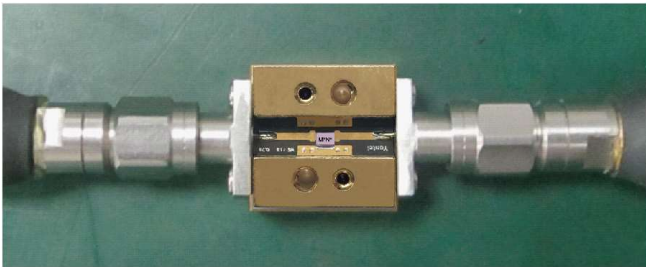

**Equipment Calibration**



**Room  
Temperature  
Test**



**High-Low  
Temperature  
Test**

- 1、 S2P documents are available for download
- 2、 DC-18GHz or 16-36GHz test fixture is rentable (only for Chinese customers) , otherwise please purchase them.

For any questions or needs, please feel free to contact [inform@yantel-corp.com](mailto:inform@yantel-corp.com).

### Package Outlines

All dimensions shown in mm unless stated otherwise  
Dimension tolerance:  $\pm 0.1\text{mm}$

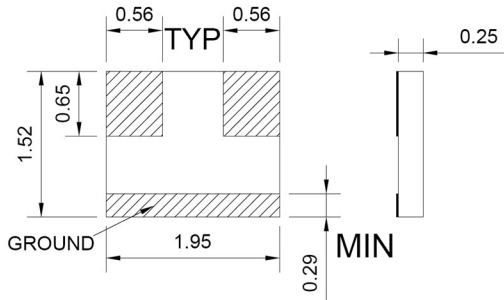

### Recommended Layout

All dimensions shown in mm unless stated otherwise

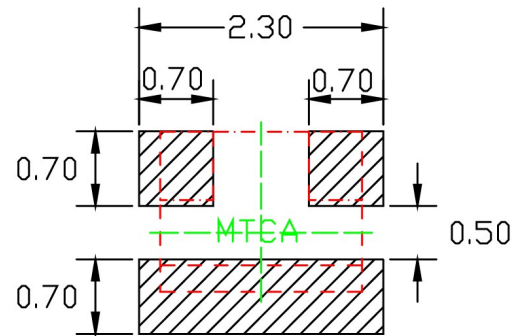

### Tape & Reel Drawing

All dimensions shown in mm unless stated otherwise

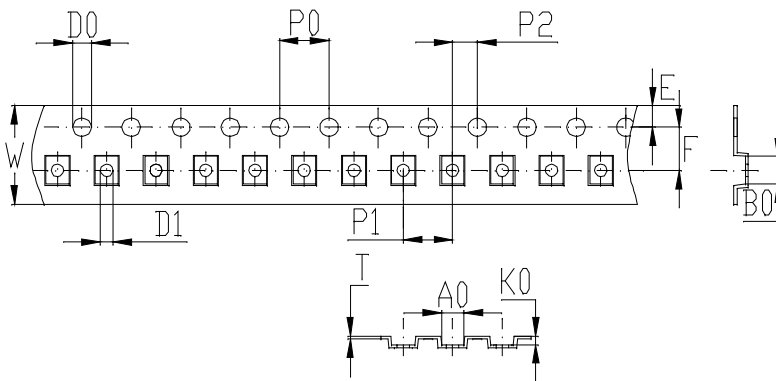

Notice:

- A. 10 Sprocket hole pitch cumulative tolerance is 0.2mm.
- B. Carrier camber shall be not more than 1mm per 100mm through a length of 250mm.
- C. All dimensions meet EIA-418-B requirements.
- D. A0 & B0 measured as indicated.
- E. K0 measured from a place on the inside bottom of the pocket to top surface of carrier.
- F. Material: PS
- G. Thickness:  $0.25 \pm 0.05\text{mm}$
- H. 5000 units (maximum) / T&R

symbol	A0	B0	K0	P0	P1	P2
spec	$1.85 \pm 0.1$	$2.25 \pm 0.1$	$0.7 \pm 0.1$	$4.0 \pm 0.1$	$4.0 \pm 0.1$	$2.0 \pm 0.1$
symbol	W	T	E	F	D0	D1
spec	$8.0 \pm 0.3$	$0.25 \pm 0.05$	$1.75 \pm 0.1$	$3.5 \pm 0.1$	$\Phi 1.5^{+0.1}_{-0.0}$	$\Phi 1.0^{+0.1}_{-0.0}$

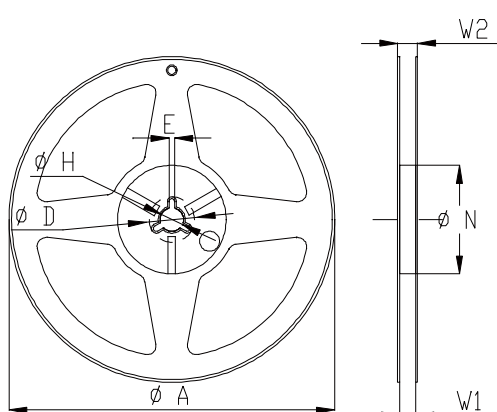

Symbol	Dimensions(mm)
A	$180^{+0/-3}$
N	$60^{+1/-0}$
W1	$9.0 \pm 0.3$
W2	$11 \pm 1.0$
D	$25 \pm 0.8$
H	$13 \pm 0.2$
E	$3 \pm 0.5$

