

Microwave Temperature Compensation Attenuator DC~20GHz 50Ω 200mW
Part No. Descriptions

**** Series	** Frequency	** Attenuation	** Temperature Coefficient Code	** Metallization Options	* Thickness
MTCAS	20	(01 to 10) 1dB to 10dB	(N3 to N10)	Planar(no code), W1, W3, WB1 or G	(no code)=0.25mm T=0.22mm

Metallization Options

- Planar(no code): planar terminal
- Single wrap(W1): metallization wrap ground terminal.
- Triple wrap(W3): metallization wrap input, output and ground terminal.
- Wire bond(WB1): metallization wrap ground terminal, input and output terminal have gold metallization for wire bonding.
- Planar gold(G): planar terminal with gold metallization for wire bonding.

Part No.	Frequency Range (GHz)	Attenuation (dB)	Temperature Coefficient Code	Temperature Coefficient of Attenuation (dB/dB/°C)	VSWR (:1) @1GHz@25°C Typ.	Max. Input Power (mW)	Attenuation Accuracy (dB)@25°C Typical		
							@ 1GHz	@ 18GHz	@ 20GHz
MTCAS2001N*	DC-20	1	N3~N10	-0.003~ -0.010	1.20	200	±0.5	±1.0	±1.3
MTCAS2002N*	DC-20	2	N3~N10	-0.003~ -0.010	1.20	200	±0.5	±1.0	±1.3
MTCAS2003N*	DC-20	3	N3~N10	-0.003~ -0.010	1.20	200	±0.5	±1.0	±1.3
MTCAS2004N*	DC-20	4	N3~N10	-0.003~ -0.010	1.20	200	±0.5	±1.0	±1.3
MTCAS2005N*	DC-20	5	N3~N10	-0.003~ -0.010	1.20	200	±0.5	±1.0	±1.3
MTCAS2006N*	DC-20	6	N3~N10	-0.003~ -0.010	1.20	200	±0.5	±1.0	±1.3
MTCAS2007N*	DC-20	7	N3~N10	-0.003~ -0.010	1.20	200	±0.5	±1.0	±1.3
MTCAS2008N*	DC-20	8	N3~N10	-0.003~ -0.010	1.20	200	±0.5	±1.0	±1.3
MTCAS2009N*	DC-20	9	N3~N10	-0.003~ -0.010	1.20	200	±0.5	±1.0	±1.3
MTCAS2010N*	DC-20	10	N3~N10	-0.003~ -0.010	1.20	200	±0.5	±1.0	±1.3

General Specifications

- Frequency Range DC-20GHz
- Attenuation 3dB
- Attenuation Accuracy at 25°C,±0.5dB typical @1GHz
±1dB typical @18GHz
±1.3dB typical @20GHz
- VSWR at 25°C,1.40:1 typical @ DC~20GHz
- Nominal Impedance 50 Ω
- Power Rating 200 mW CW
- Power Derating 100% @ 125°C,Derates to 0% @ 150°C
- Operating Temperature -55°C~+150°C
- The temperature coefficient within the operating temperature range is shown in the above table.
Tolerance of temperature coefficient: ±0.001dB/dB/°C.
- Substrate: Alumina (Al₂O₃)
- Resistive material: Thick film
- Terminal material: Thick film, Input, Output and front Ground all made by gold,Back Ground made by Pd/Ag.
- Protective Coating: Thick film (ethyl acetate)
- Package Outline: See Sheet 4.
- Workmanship: per MIL-PRF-55342.
- RoHS Compliant.
- Electrostatic Discharge Control: per MIL-STD-1686.

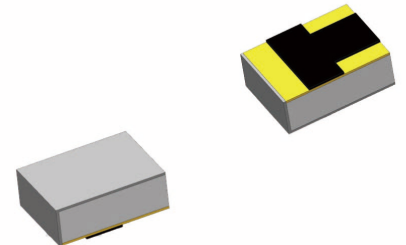
Yantel Corporation

 Add: No.308-322,3F,Building 1,Juchuang Jingu Innovation Park,Wenyuan Road 35,Xili Street,Nanshan,Shenzhen,China
 Tel: 86-755-8355-1886 Fax: 86-755-8355-2533

 For detailed performance specs & shopping online see Yantel web site : www.yantel-corp.com

Features:

1. DC-20GHz ultra-compact ultra-wideband.
2. Size 0.8*0.6*0.25 or 0.22mm, gold electrode, size & thickness consistent with active temperature compensation attenuation chip, easy to use.
3. Gold wire bonding, input and output pad size 0.17*0.31mm.
4. N3~ N10 Various slopes are available.
5. High reliability, no need for extra-5V power supply.
6. Improve impedance matching, reduce return loss between 2 adjacent power amplifiers, play an isolation protection role, and effectively prevent self-excitation.
7. Compared to active temperature compensation attenuators, passive one exhibit no distortion, phase shift, or time delay.
8. The application system is simple and flexibl with high reliability, reducing the hidden costs associated with system redesign.
9. When power increases, passive temperature compensation attenuators provide better and more stable temperature and frequency response characteristics than active tones, offering higher reliability.
10. Ultra small design, supporting for small multi-channel active phased array radars and chip-level micro-miniature transceiver module.

Applications:

- Miniaturized multi-channel active phased array radar
- Chip-level micro-miniature packaged transceiver modules
- Small active phased array radar for unmanned aerial vehicles

Unit Marking

dB Value (XX), Direction of Shift (N) and TCA Shift (X).
 Legibility and Permanency: per MIL-STD-130.

Quality Assurance

1. Sample inspect per ANSI/ASQC Z1.4 general inspection, LEVEL II, AQL = 1.0.
 - 1.1 Visual and mechanical examination for conformance to outline package requirements.
2. Select five (5) Units from lot measure attenuation from DC to 20 GHz every 20°C over the temperature range -55°C to +125°C.
 - 2.1 Calculate, using linear regression, the slope of the curve.
 - 2.2 Calculate TCA using the following formula: TCA = Slope / Attenuation @ 25°C.
3. Test data required for customer.

Typical VSWR, 25°C



Power Rating & Derating Curve

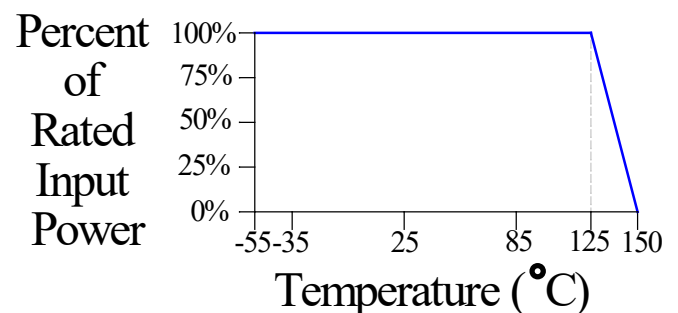

Yantel Corporation

Add: No.308-322,3F,Building 1,Juchuang Jingu Innovation Park,Wenyuan Road 35,Xili Street,Nanshan,Shenzhen,China
 Tel: 86-755-8355-1886 Fax: 86-755-8355-2533

For detailed performance specs & shopping online see Yantel web site : www.yantel-corp.com

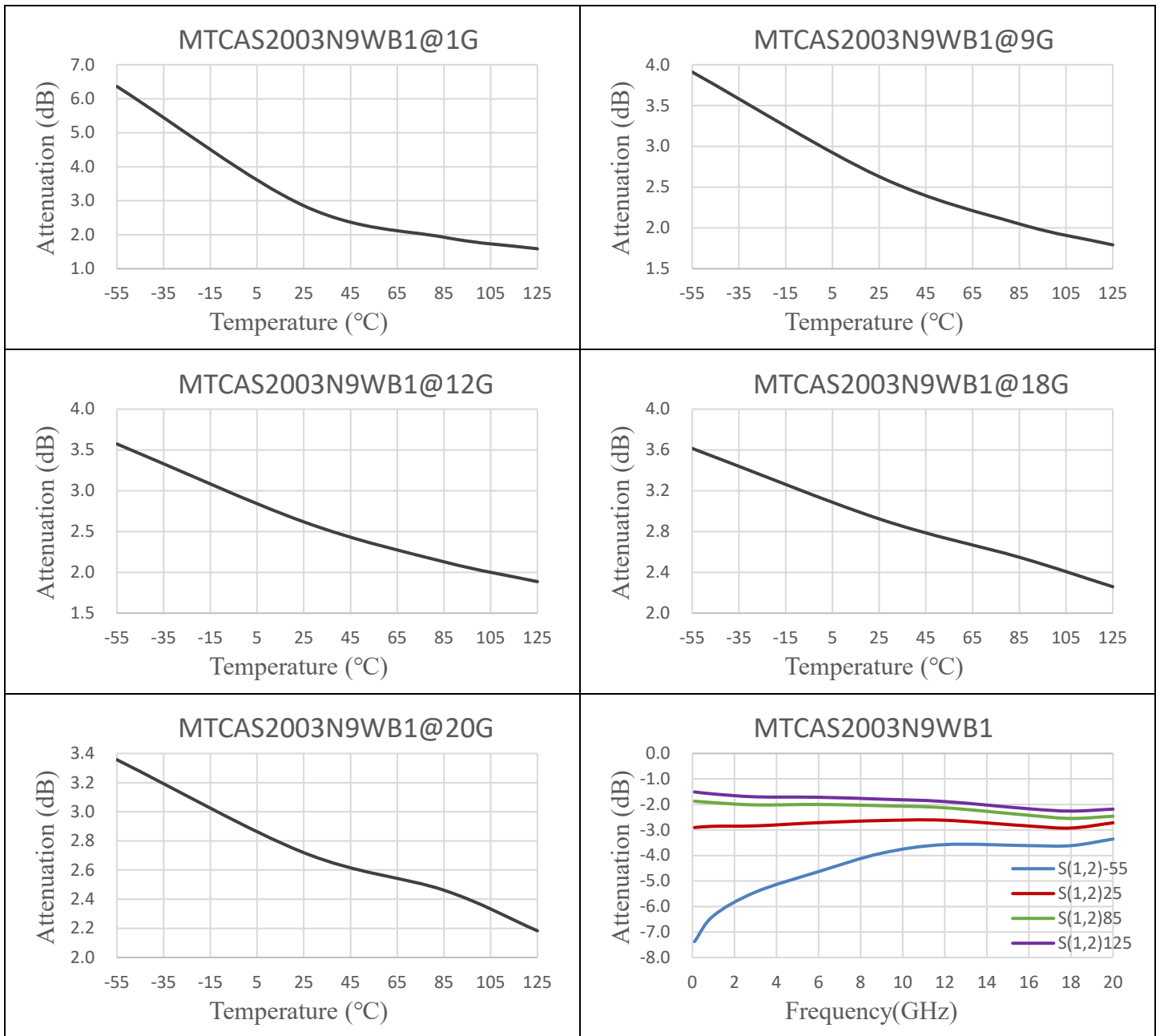
MTCAS Response

PN:	F(Hz) T(°C)	Attenuation(dB)								Return Loss(dB)							
		1G	3G	6G	9G	12G	16G	18G	20G	1G	3G	6G	9G	12G	16G	18G	20G
MTCAS2003N9WB1	25	2.85	2.84	2.71	2.63	2.62	2.84	2.92	2.72	27.55	24.58	31.00	21.89	23.36	16.79	15.28	19.69
	-55	6.36	5.44	4.63	3.91	3.57	3.61	3.61	3.36	13.39	13.81	15.83	24.52	25.60	14.50	12.88	16.87
	85	1.93	2.02	2.00	2.05	2.13	2.42	2.55	2.46	40.54	33.66	35.44	20.64	21.95	16.98	15.29	18.10
	125	1.59	1.70	1.72	1.79	1.89	2.17	2.26	2.18	32.23	34.41	30.12	20.55	21.06	15.85	15.29	16.44
	N value:	9.29	7.31	5.97	4.47	3.58	2.82	2.58	2.40								

Yantel Corporation

Add: No.308-322,3F,Building 1,Juchuang Jingu Innovation Park,Wenyuan Road 35,Xili Street,Nanshan,Shenzhen,China

Tel: 86-755-8355-1886 Fax: 86-755-8355-2533

 For detailed performance specs & shopping online see Yantel web site : www.yantel-corp.com

Notes on RF Testing and Circuit Layout:

DC-20GHz WB1 series(for Gold Terminal type) Test Fixture



WB1 PCB Test Board



Connect test part to Test Fixture



Equipment Calibration



Room
Temperature
Test



High-Low
Temperature
Test



- 1、 S2P files are available for download.
 - 2、 DC-20GHz or 16-36GHz test fixture is rentable (only for Chinese customers) ,otherwise please purchase them.
- For any questions or needs, please feel free to contact inform@yantel-corp.com

Yantel Corporation

Add: No.308-322,3F,Building 1,Juchuang Jingu Innovation Park,Wenyuan Road 35,Xili Street,Nanshan,Shenzhen,China
Tel: 86-755-8355-1886 Fax: 86-755-8355-2533

For detailed performance specs & shopping online see Yantel web site : www.yantel-corp.com

Package Outlines

All dimensions shown in mm unless stated otherwise

Dimension tolerance: $\pm 0.1\text{mm}$

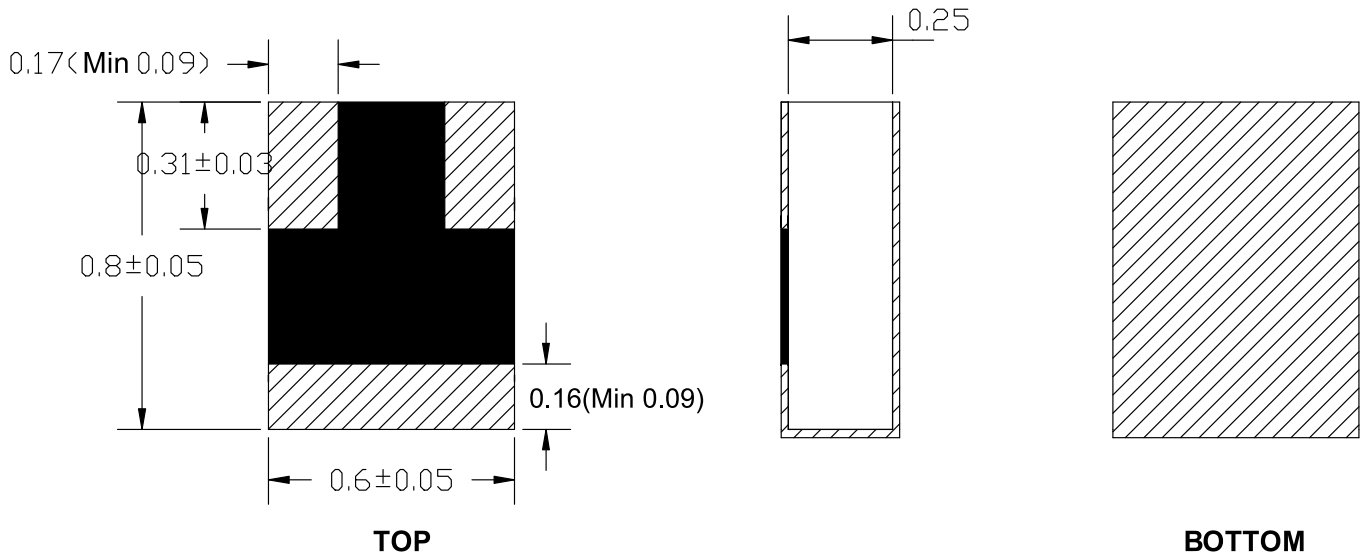

Recommended Layout

All dimensions shown in mm unless stated otherwise

