

Data Sheet

QF1880Q06A

Quadrifilar Directional Coupler

1165 MHz-2600 MHz

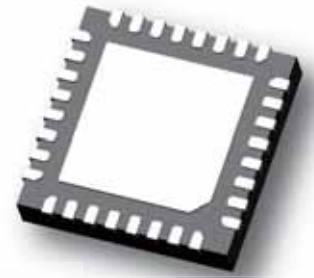

Features

- Ultra Small Size (4×4mm)
- Excellent phase & amplitude balance
- Excellent repeatability
- Passive RF IC, no need external DC power supply
- With internal 50 ohm termination (no need external termination)
- Built with leading edge RFIC design technology
- Have three Input port and Twelve Output ports that have -6dB $-(0^\circ, 90^\circ, 180^\circ, 270^\circ)$ of phase difference
- Quadrifilar Coupler, 4-Phased Antenna Feeder, Helicaled Antenna Feeder
- Operating Temperature: -40°C to $+85^\circ\text{C}$
- Tape & Reel

Applications

- Realizing the World's Most Compact High Precision GNSS Antenna (GPS, Beidou, Galileo, Glonass)

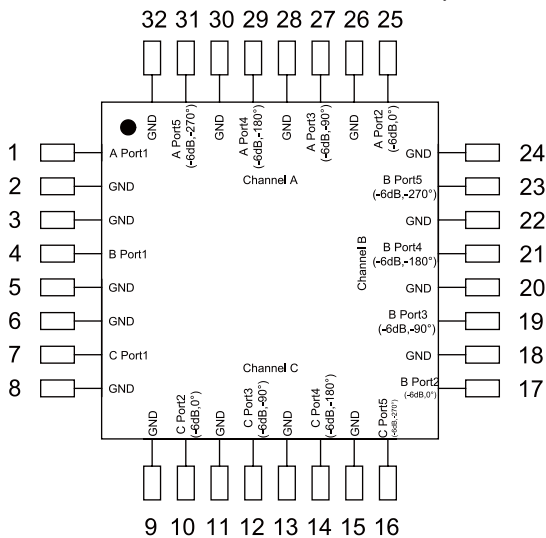

TOP VIEW

A Port 1	A Port 2	A Port 3	A Port 4	A Port 5
Input	Output1 -6dB, 0°	Output2 -6dB, -90°	Output3 -6dB, -180°	Output4 -6dB, -270°
B Port 1	B Port 2	B Port 3	B Port 4	B Port 5
Input	Output1 -6dB, 0°	Output2 -6dB, -90°	Output3 -6dB, -180°	Output4 -6dB, -270°
C Port 1	C Port 2	C Port 3	C Port 4	C Port 5
Input	Output1 -6dB, 0°	Output2 -6dB, -90°	Output3 -6dB, -180°	Output4 -6dB, -270°

Electrical Specifications at 25°C

Channel	Freq. Range (MHz) FL~FU	Power (W)	Size LxW (mm)	Typical Return Loss (dB)	Typical Insertion Loss (dB)	Typical Isolation (dB)	Typical Phase Balance (deg)	Typical Amplitude Balance (dB)
Channel A	1165-1300	4	4×4	11-40	1.15	9-17	-9~0	±0.5
Channel B	1520-1660			11-27	1.02	10-16	-8~0	±0.9
Channel C	2400-2600			12	1.45	9	-10~+6	±0.9

Yantel Corporation

A1.0

Add: 3F, Building 3, Southern District 2 of Zhongguan Honghualing Industrial Park, Xili, Nanshan, Shenzhen, China
Tel: 86-755-8355-1886 Fax: 86-755-8355-2533

For detailed performance specs & shopping online see Yantel web site : www.yantel-corp.com

Data Sheet
QF1880Q06A 1165 MHz-2600 MHz
Quadrifilar Directional Coupler
Channel A 1165 MHz-1300 MHz

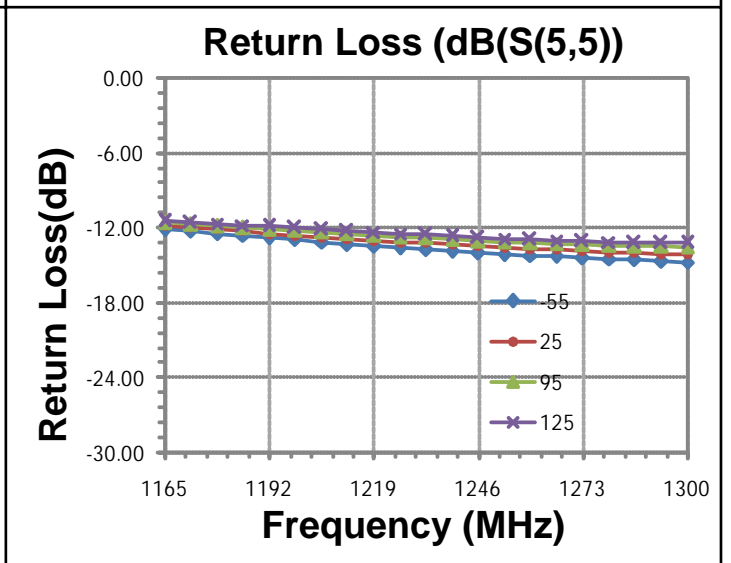
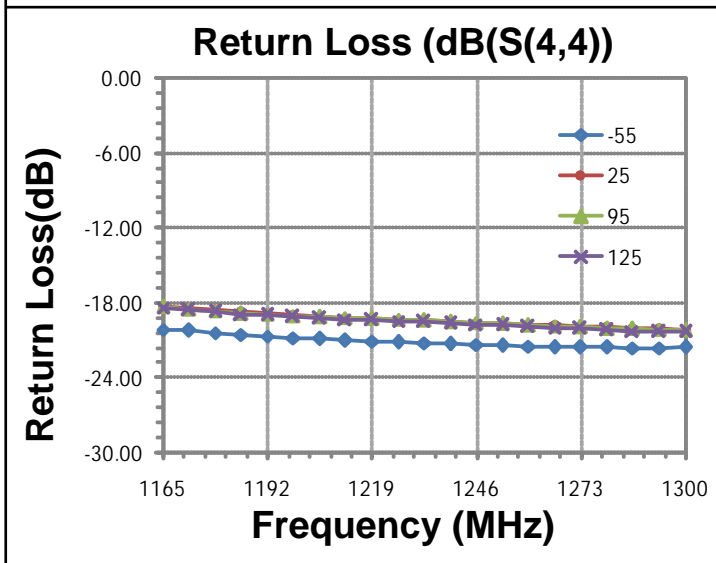
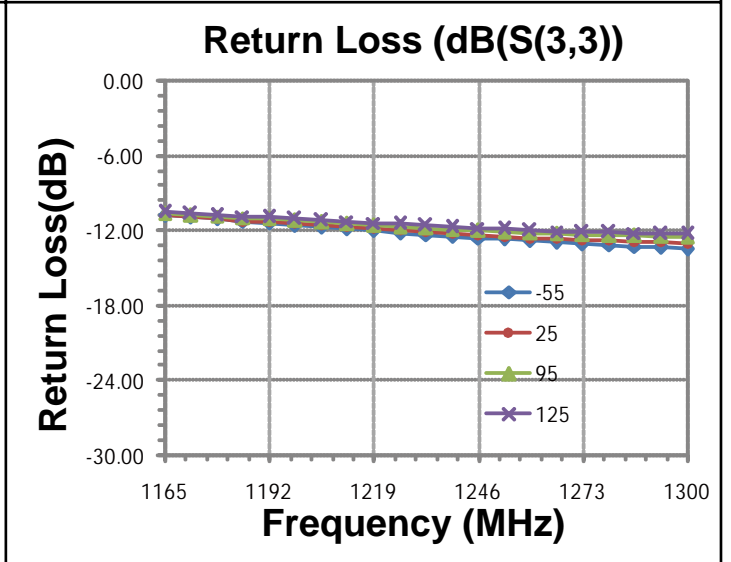
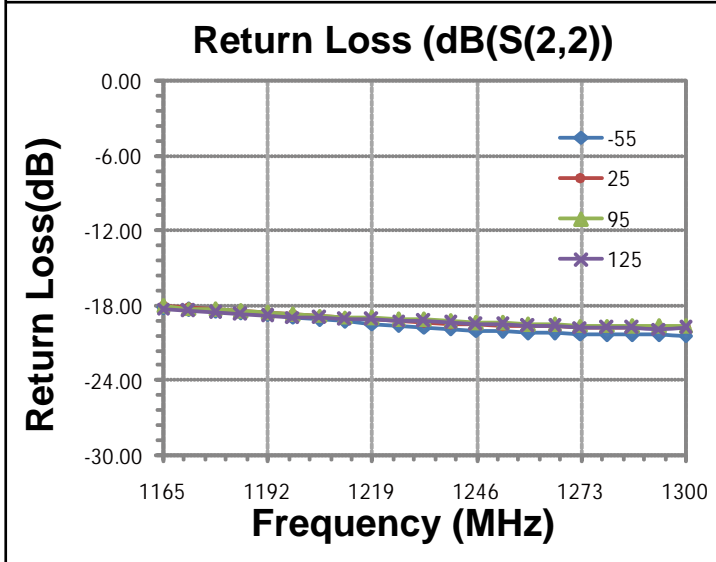
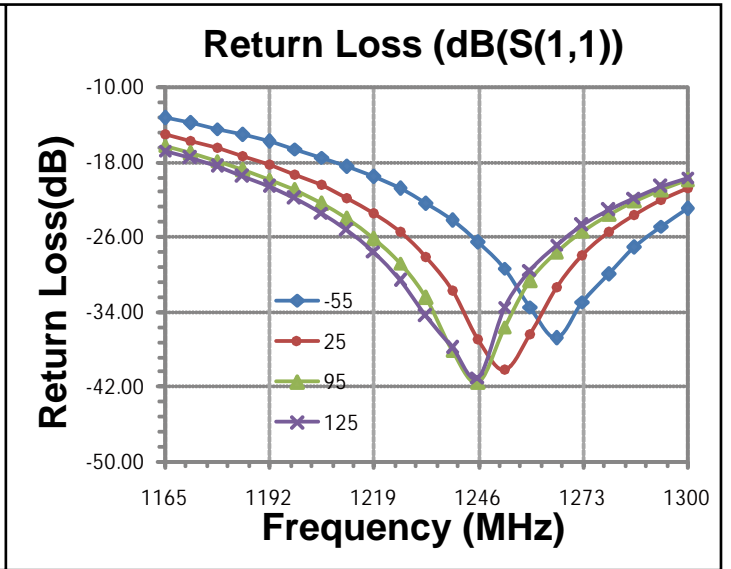
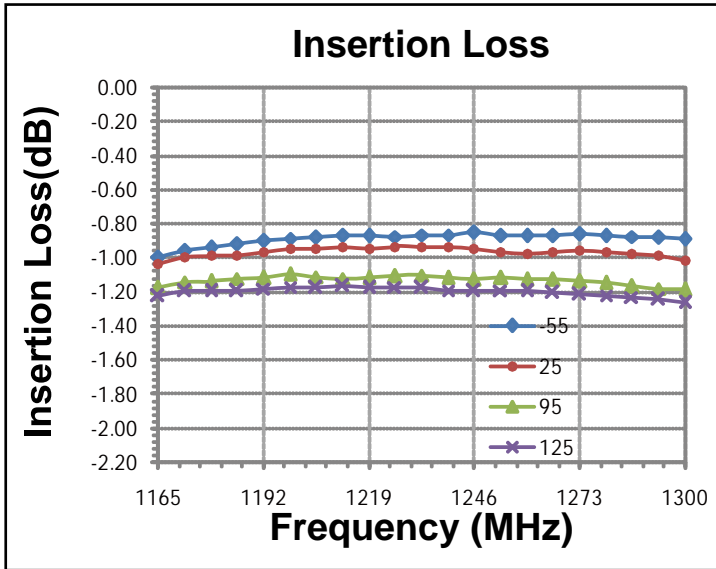

Yantel Corporation

Data Sheet
QF1880Q06A 1165 MHz-2600 MHz
Quadrifilar Directional Coupler
Channel A 1165 MHz-1300 MHz

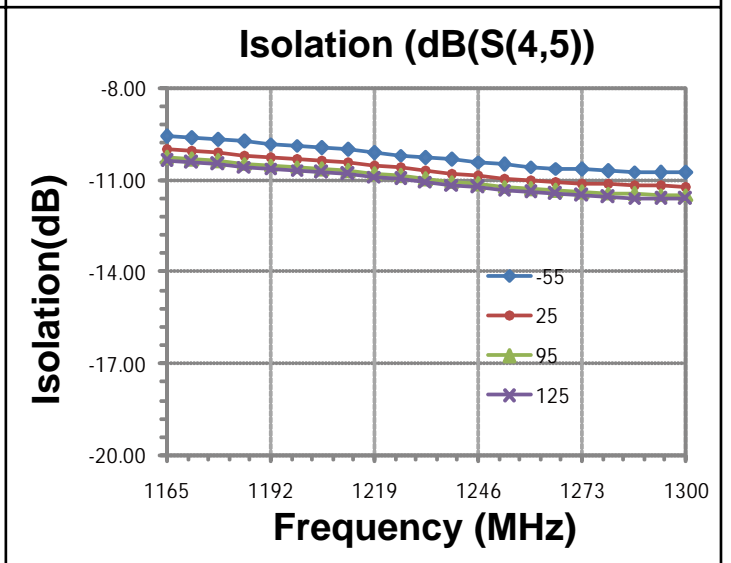
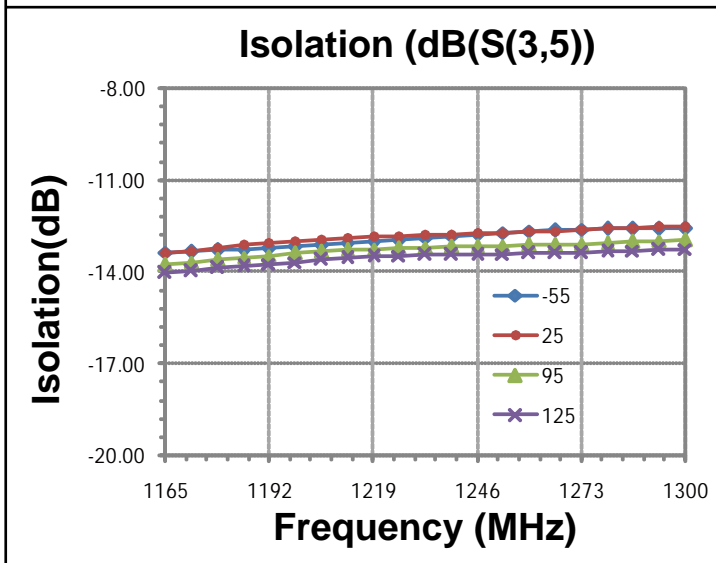
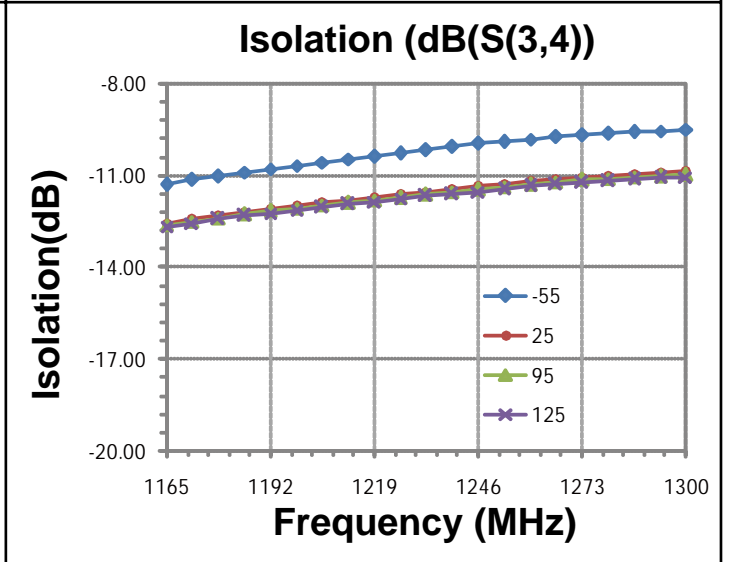
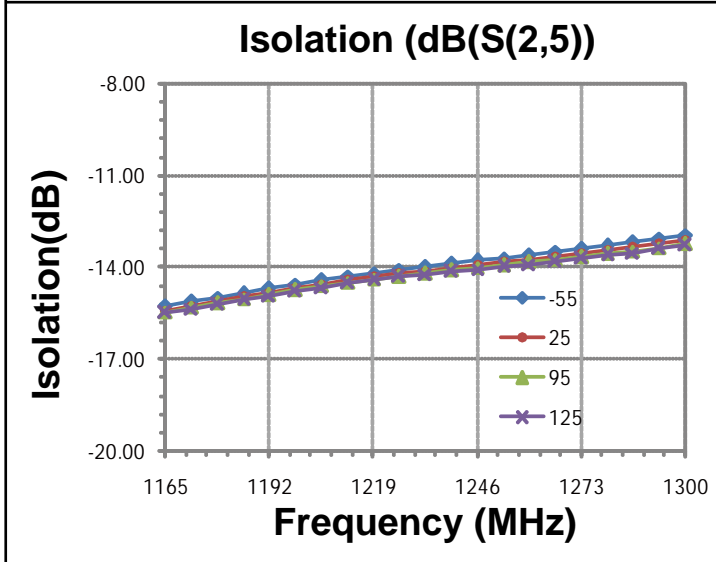
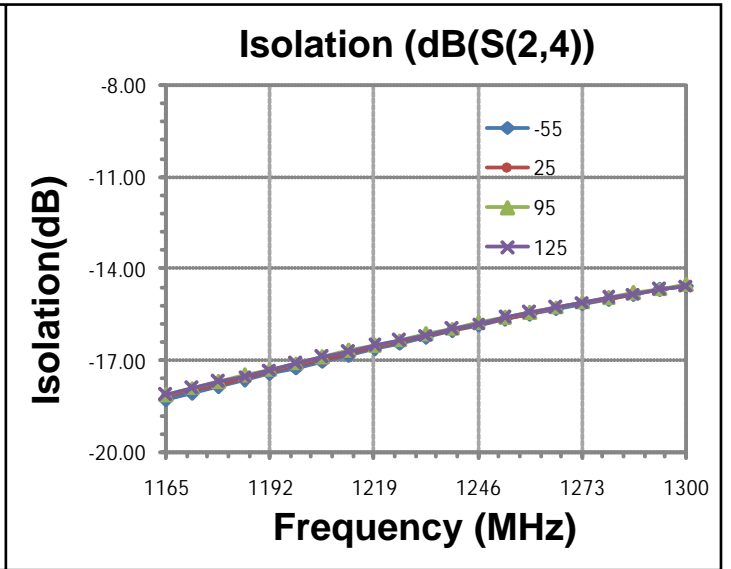
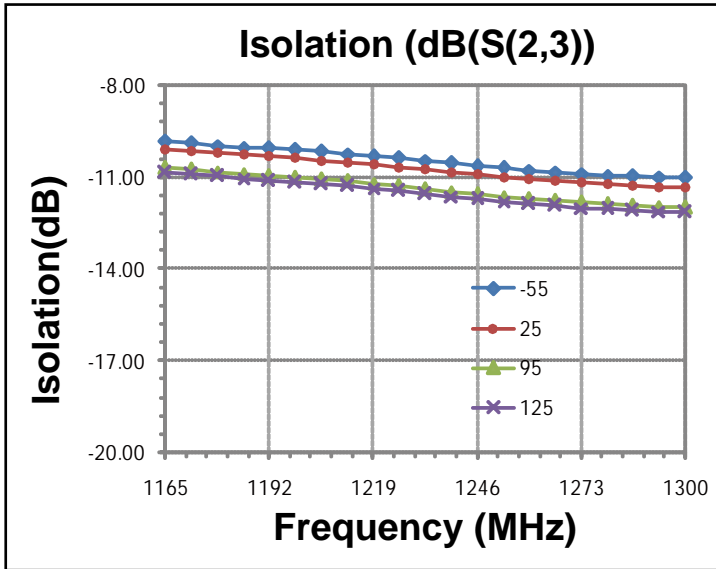

Yantel Corporation

Data Sheet
QF1880Q06A 1165 MHz-2600 MHz
Quadrifilar Directional Coupler
Channel A 1165 MHz-1300 MHz

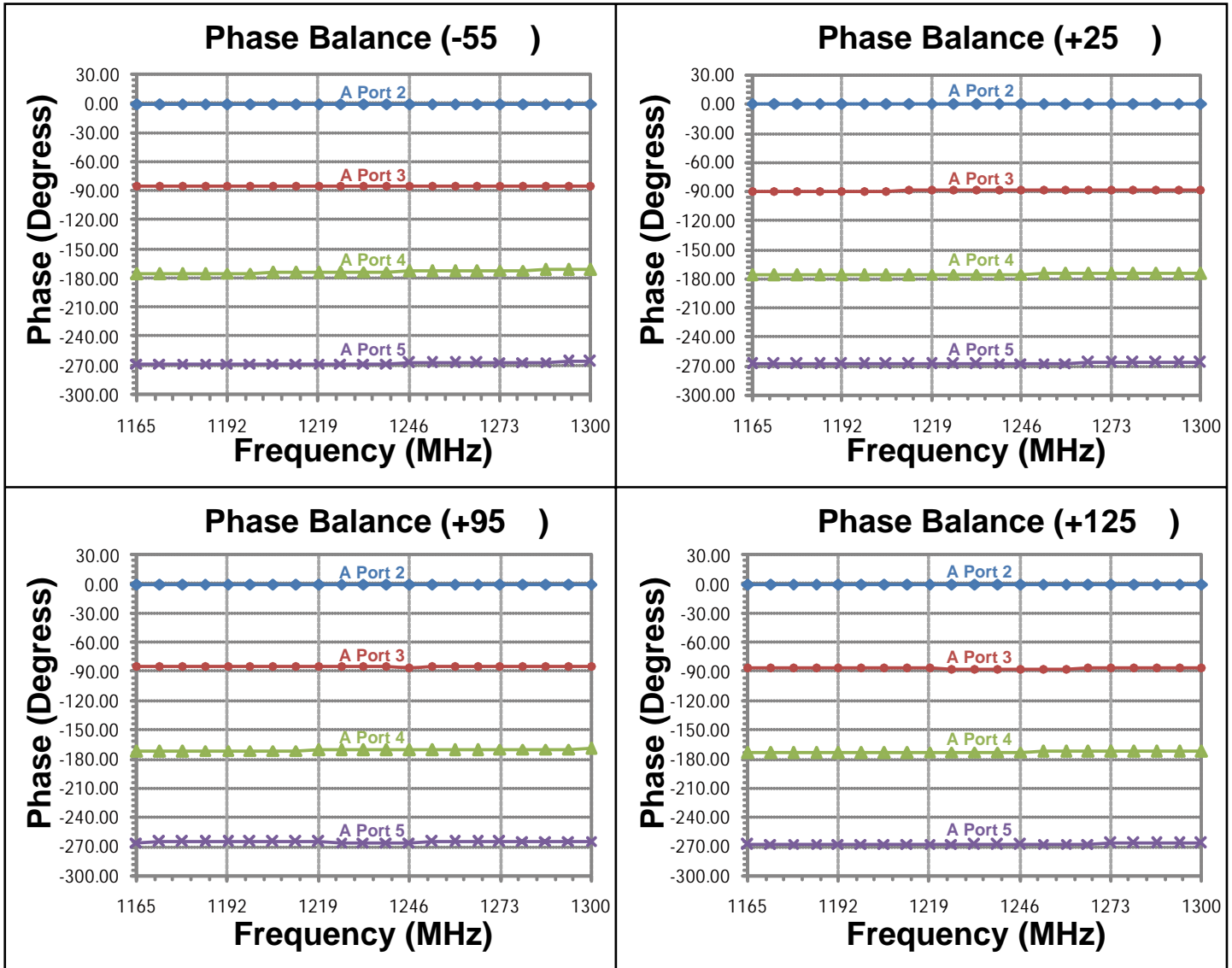

Yantel Corporation

A1.0

Add : 3F, Building 3, Southern District 2 of Zhongguan Honghualing Industrial Park, Xili, Nanshan, Shenzhen, China

Tel : 86-755-8355-1886 Fax : 86-755-8355-2533

For detailed performance specs & shopping online see Yantel web site : www.yantel-corp.com

Data Sheet
QF1880Q06A 1165 MHz-2600 MHz
 Quadrifilar Directional Coupler
 Channel B 1520 MHz-1660 MHz

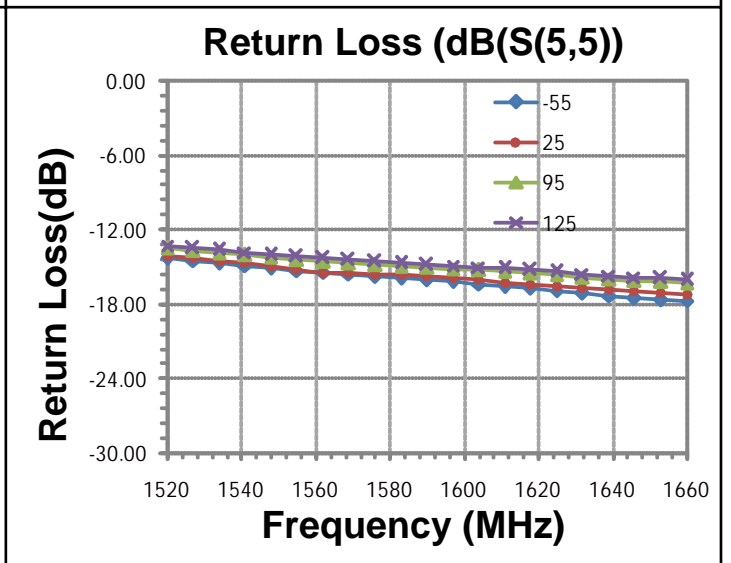
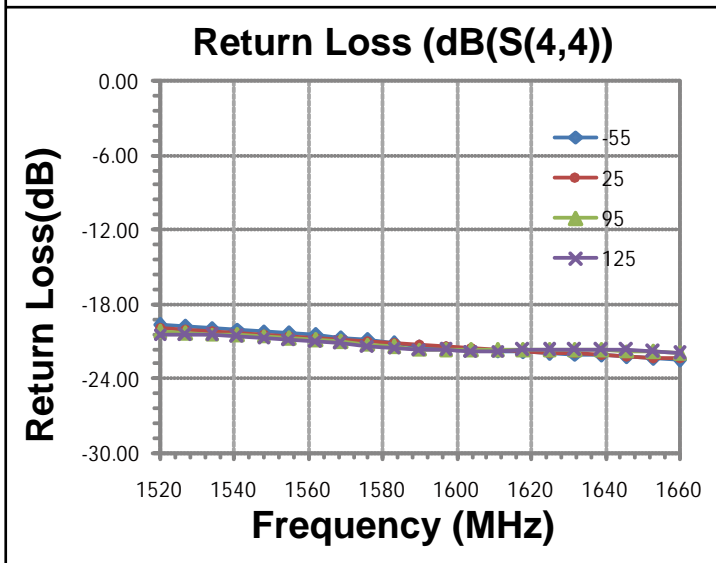
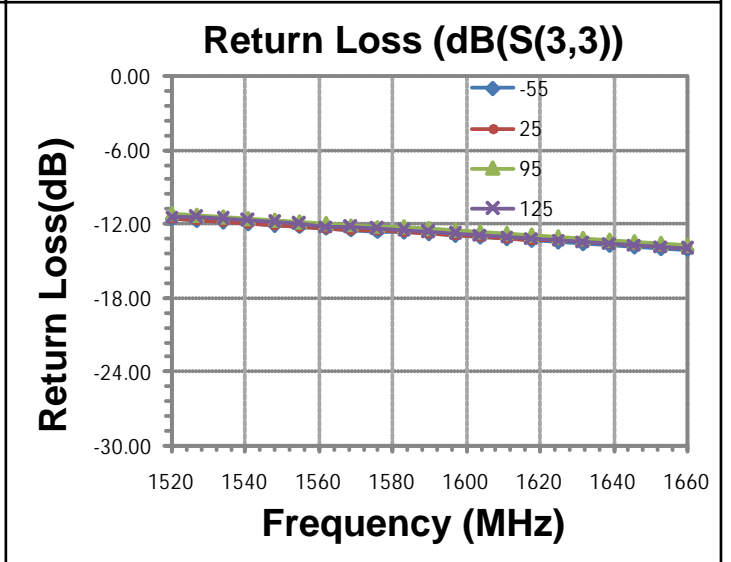
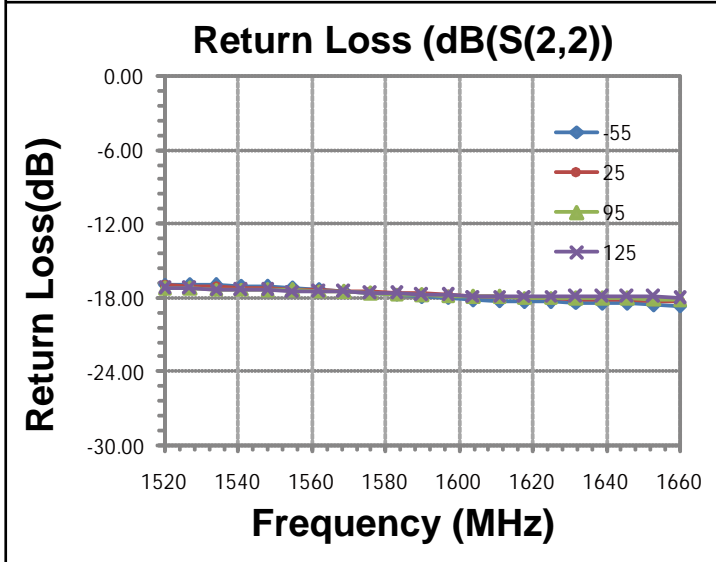
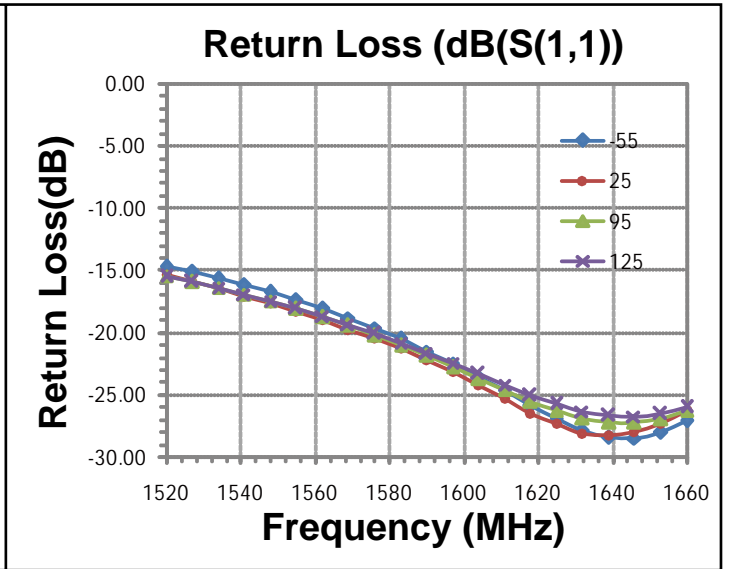
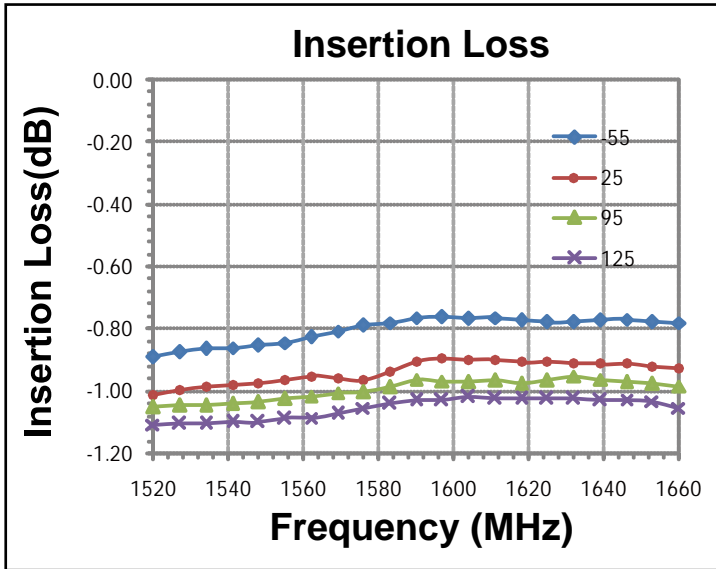

Yantel Corporation

Data Sheet

QF1880Q06A 1165 MHz-2600 MHz

Quadrifilar Directional Coupler

Channel B 1520 MHz-1660 MHz

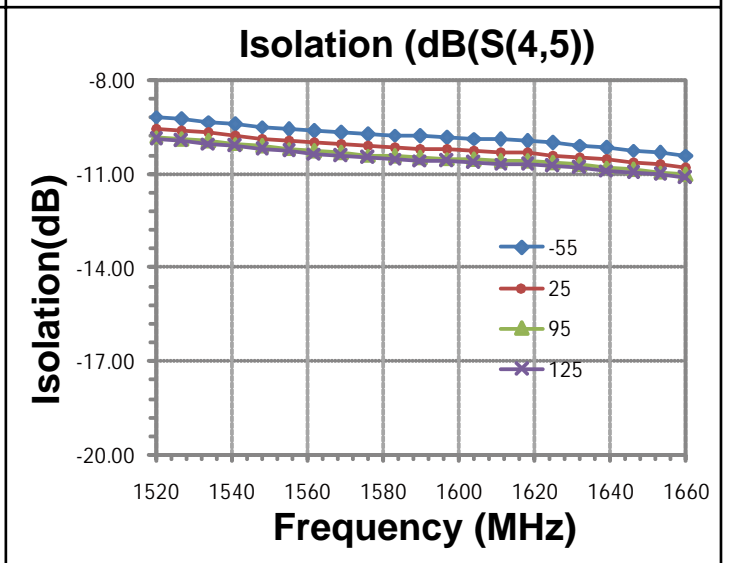
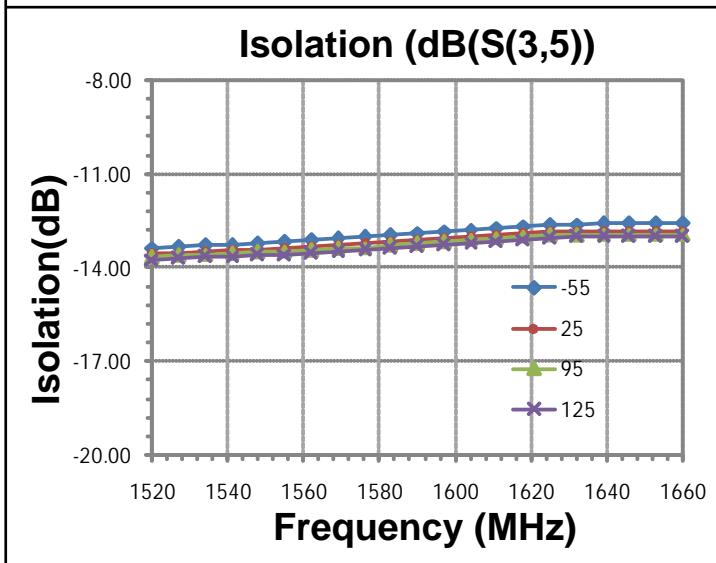
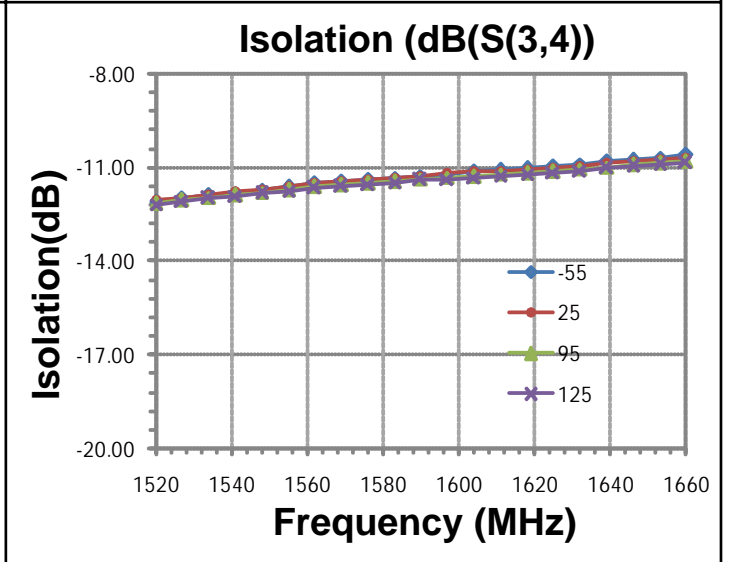
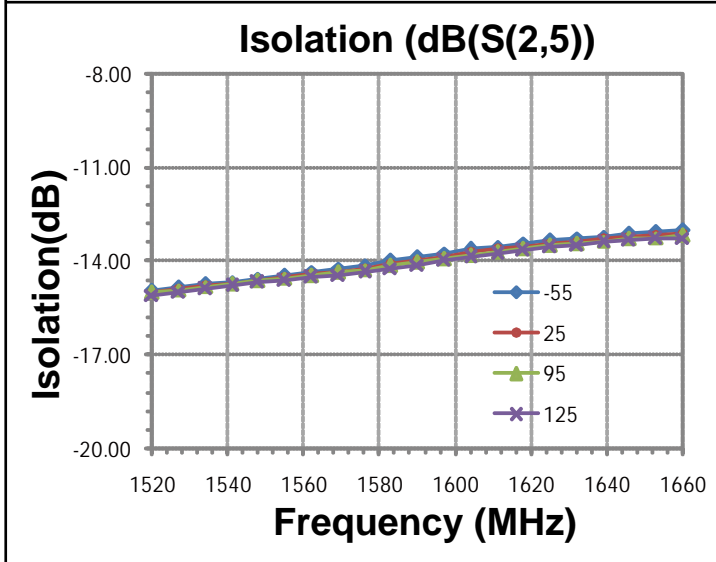
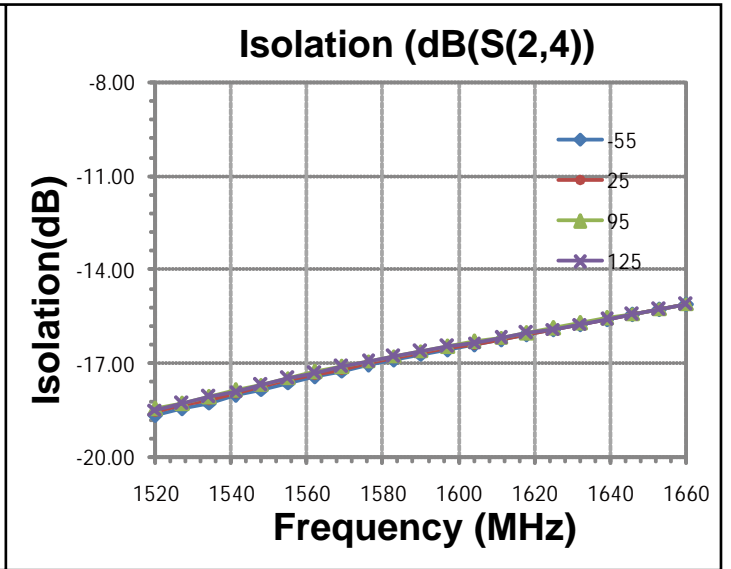
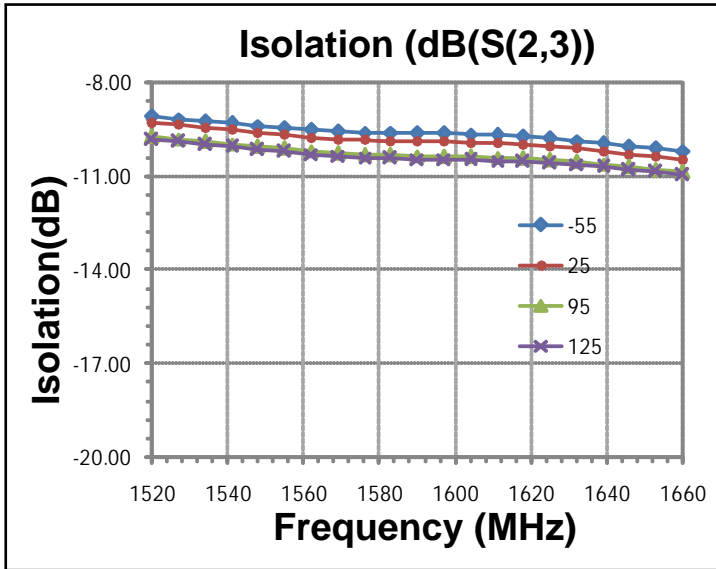

Yantel Corporation

A1.0

Add : 3F, Building 3, Southern District 2 of Zhongguan Honghualing Industrial Park, Xili, Nanshan, Shenzhen, China

Tel : 86-755-8355-1886 Fax : 86-755-8355-2533

For detailed performance specs & shopping online see Yantel web site : www.yantel-corp.com

Data Sheet
QF1880Q06A 1165 MHz-2600 MHz
Quadrifilar Directional Coupler
Channel B 1520 MHz-1660 MHz

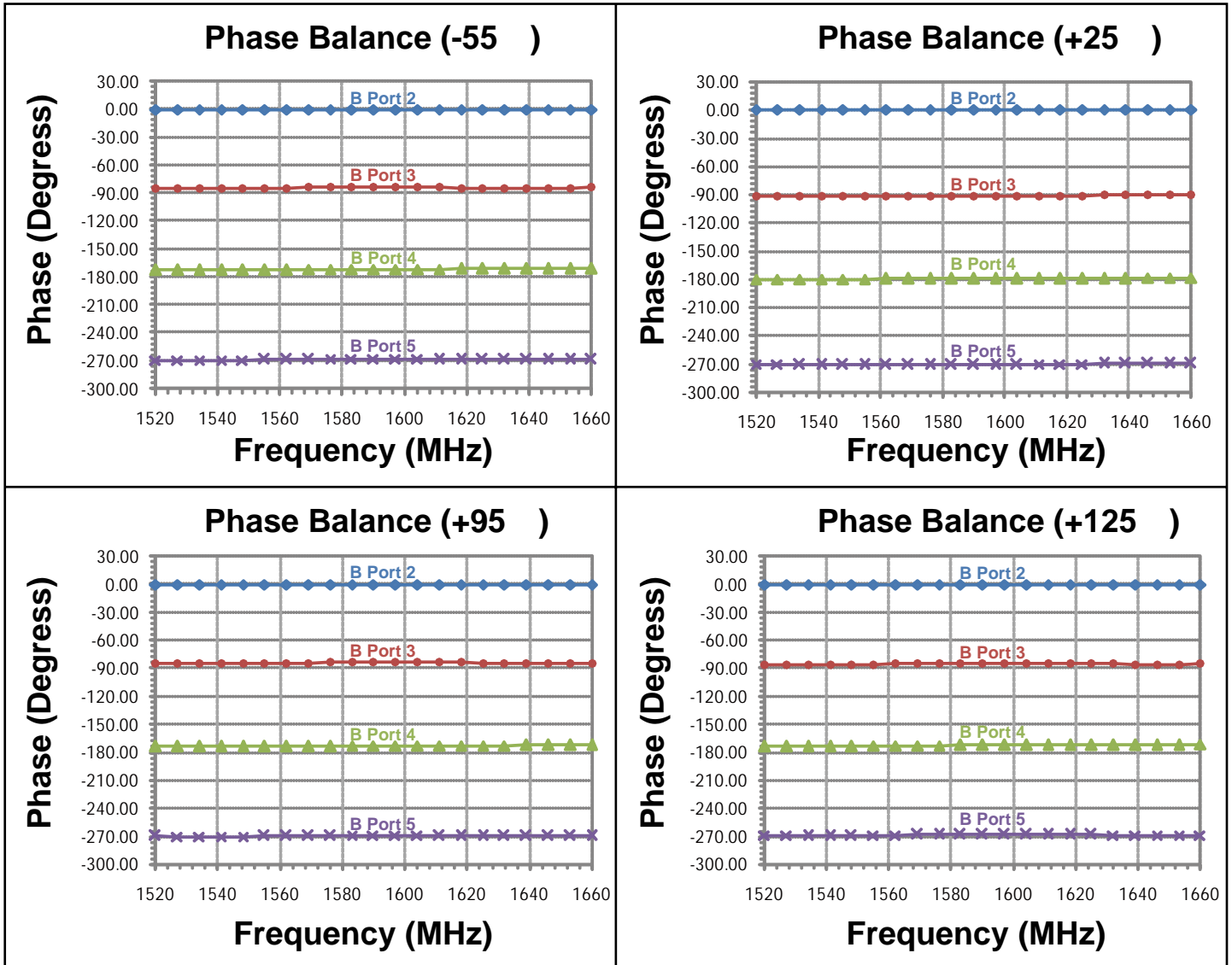

Yantel Corporation

A1.0

Add : 3F, Building 3, Southern District 2 of Zhongguan Honghualing Industrial Park, Xili, Nanshan, Shenzhen, China

Tel : 86-755-8355-1886 Fax : 86-755-8355-2533

For detailed performance specs & shopping online see Yantel web site : www.yantel-corp.com

Data Sheet
QF1880Q06A 1165 MHz-2600 MHz
 Quadrifilar Directional Coupler
 Channel C 2400 MHz-2600 MHz

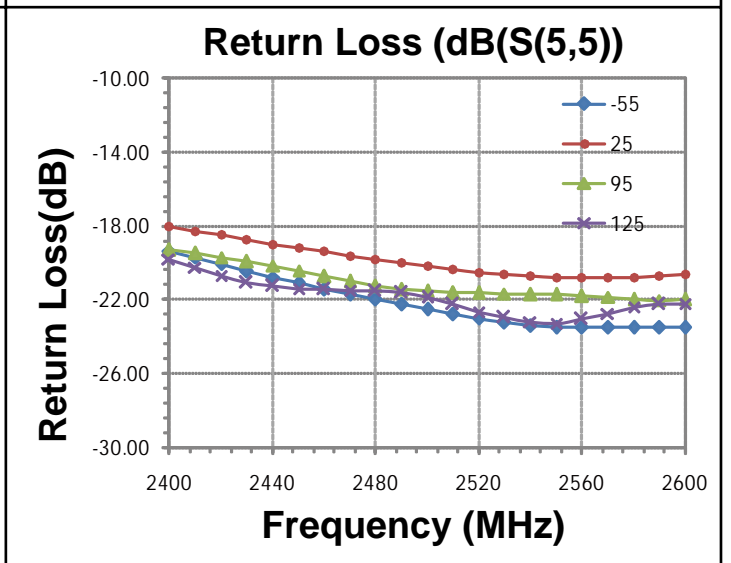
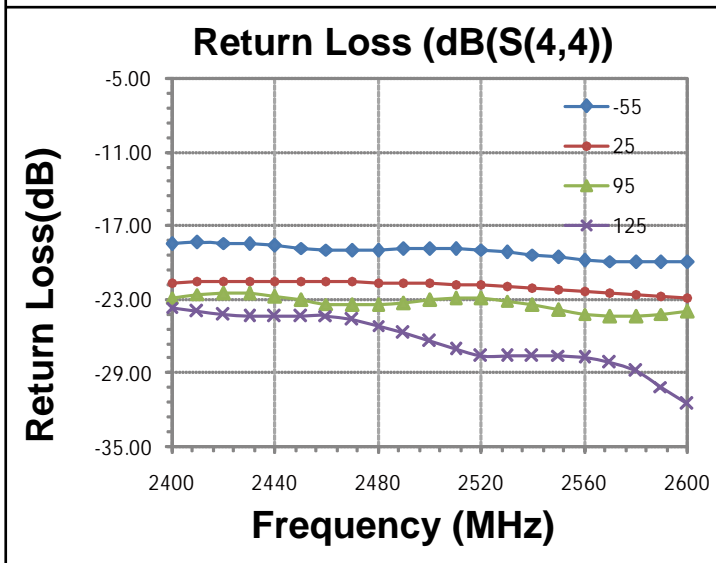
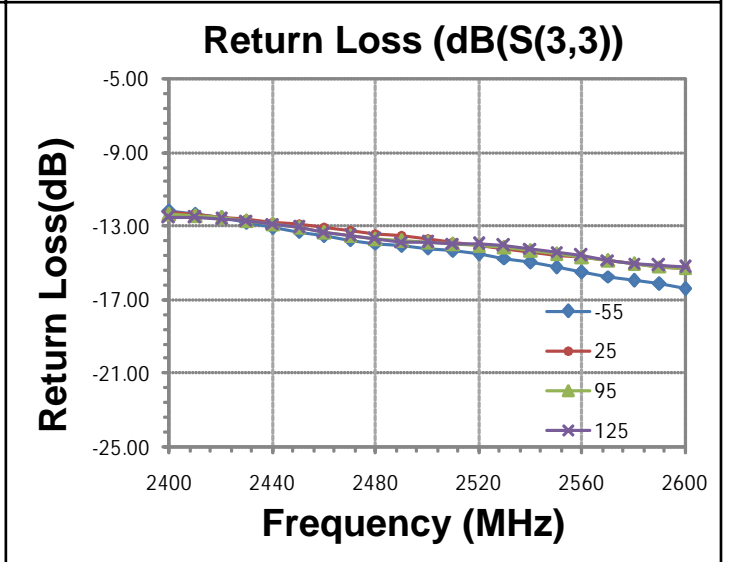
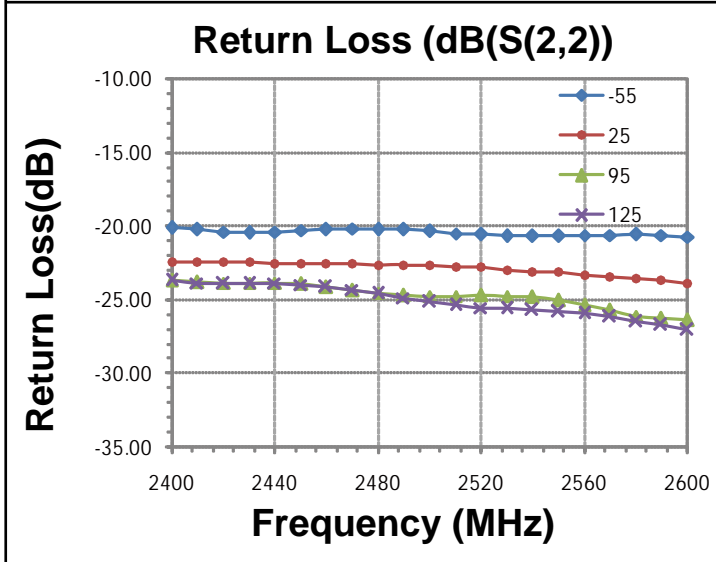
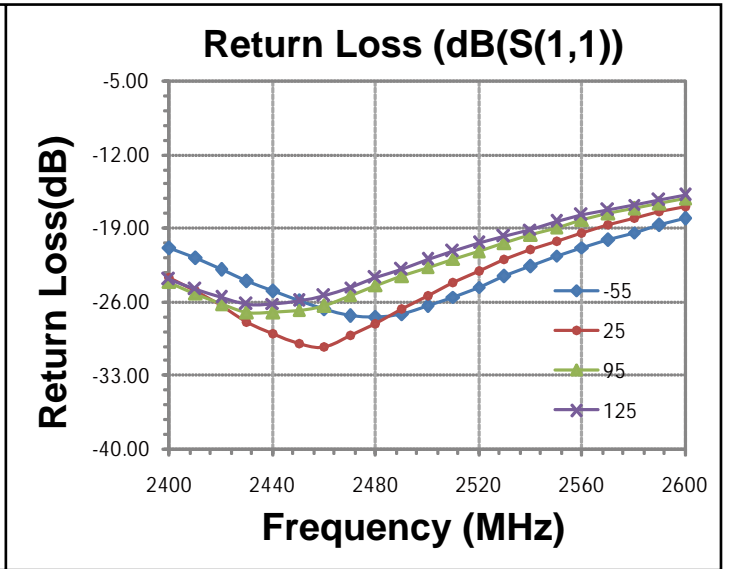
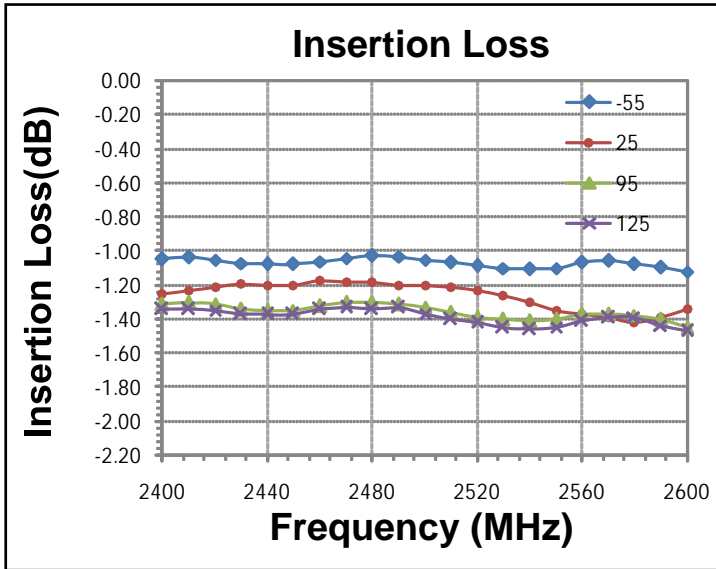

Yantel Corporation

Data Sheet
QF1880Q06A 1165 MHz-2600 MHz
Quadrifilar Directional Coupler
Channel C 2400 MHz-2600 MHz

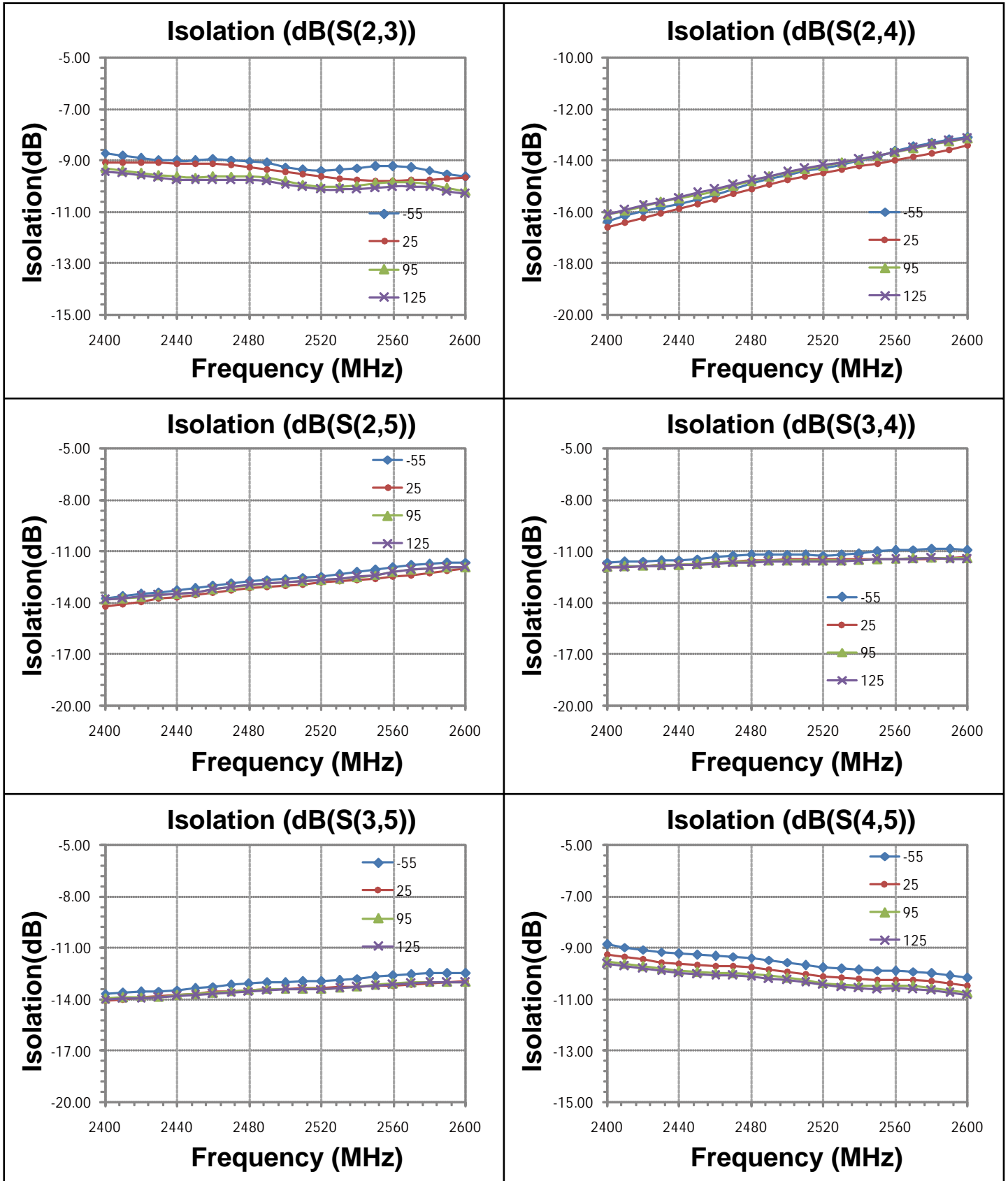

Yantel Corporation

A1.0

Add : 3F, Building 3, Southern District 2 of Zhongguan Honghualing Industrial Park, Xili, Nanshan, Shenzhen, China

Tel : 86-755-8355-1886 Fax : 86-755-8355-2533

For detailed performance specs & shopping online see Yantel web site : www.yantel-corp.com

Data Sheet
QF1880Q06A 1165 MHz-2600 MHz
 Quadrifilar Directional Coupler
 Channel C 2400 MHz-2600 MHz

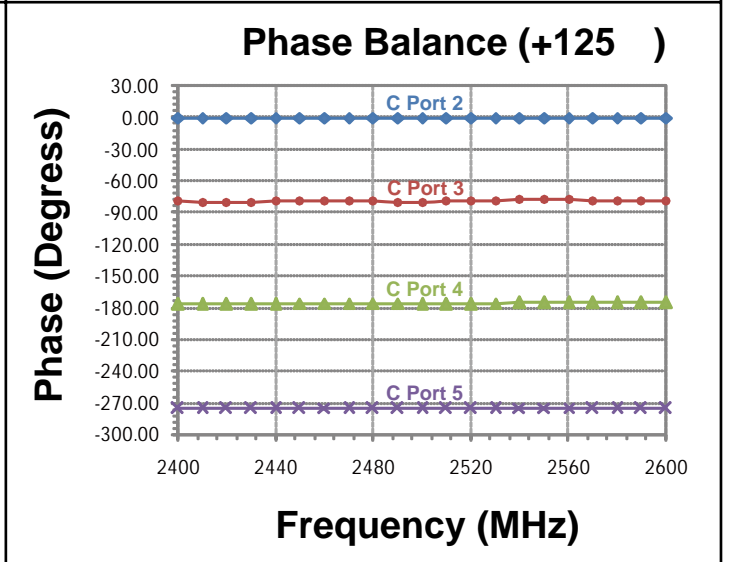
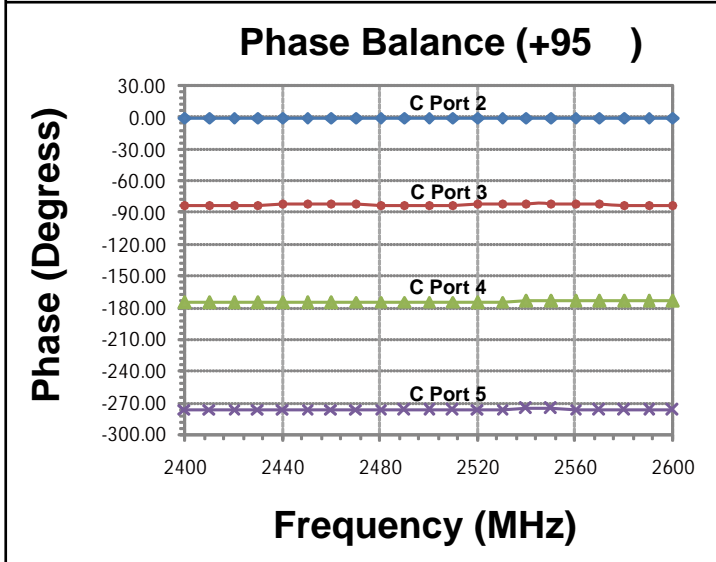
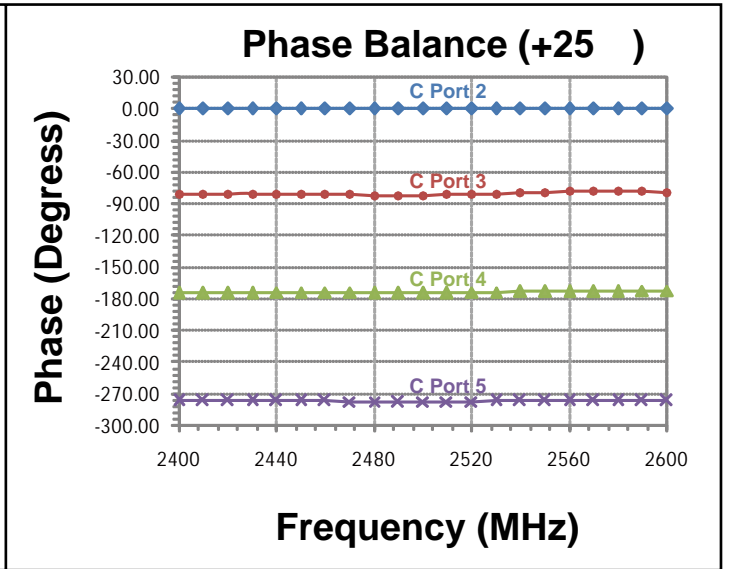
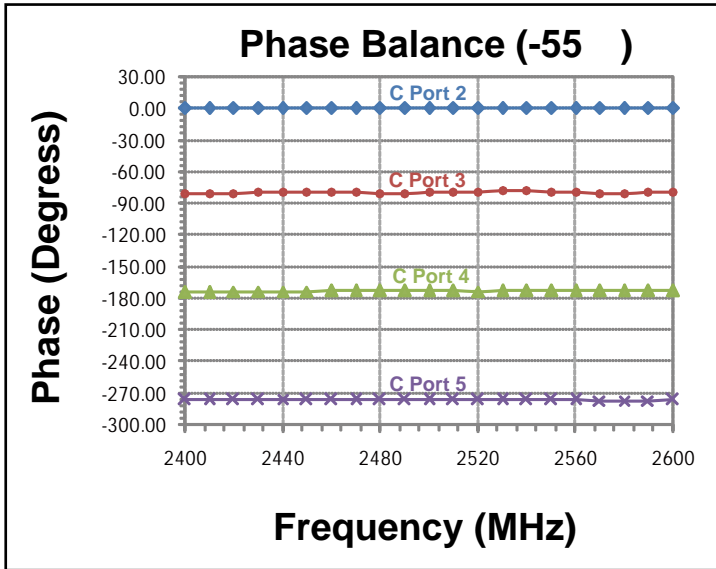

Yantel Corporation

Data Sheet

QF1880Q06A

Quadrifilar Directional Coupler
1165 MHz-2600 MHz



Special Attenuation before Quadrifilar IC Soldering

Package

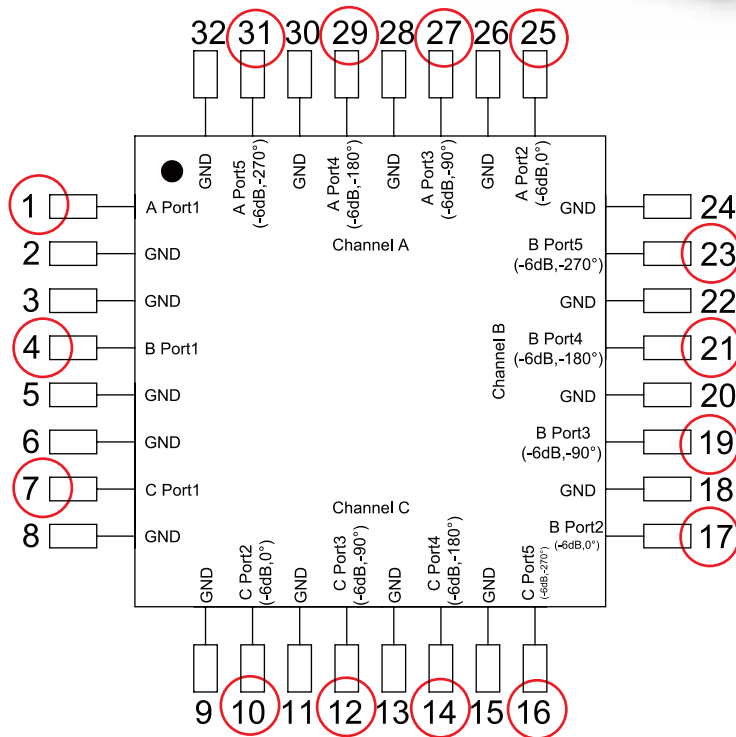

TOP VIEW

A Port 1	A Port 2	A Port 3	A Port 4	A Port 5
Input	Output1 -6dB, 0°	Output2 -6dB, -90°	Output3 -6dB, -180°	Output4 -6dB, -270°
B Port 1	B Port 2	B Port 3	B Port 4	B Port 5
Input	Output1 -6dB, 0°	Output2 -6dB, -90°	Output3 -6dB, -180°	Output4 -6dB, -270°
C Port 1	C Port 2	C Port 3	C Port 4	C Port 5
Input	Output1 -6dB, 0°	Output2 -6dB, -90°	Output3 -6dB, -180°	Output4 -6dB, -270°

Yantel Corporation

Add : 3F, Building 3, Southern District 2 of Zhongguan Honghualing Industrial Park, Xili, Nanshan, Shenzhen, China
Tel : 86-755-8355-1886 Fax : 86-755-8355-2533

Data Sheet

QF1880Q06A

Quadrifilar Directional Coupler

1165 MHz-2600 MHz



Outline Drawing

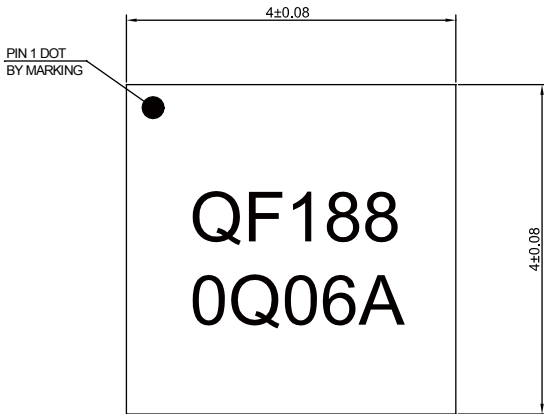

TOP VIEW

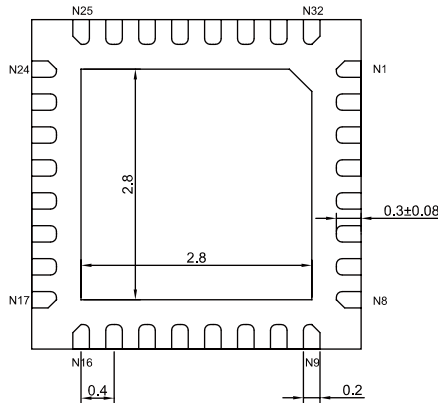

BOTTOM VIEW

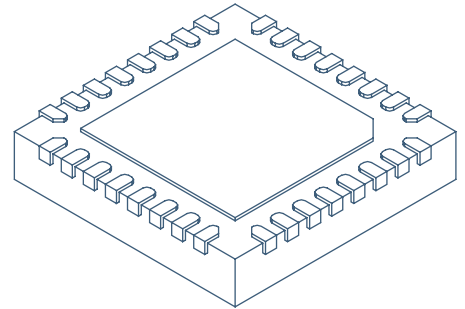

TFR-ISO VIEW

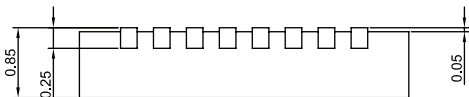

SIDE VIEW

Land Pattern

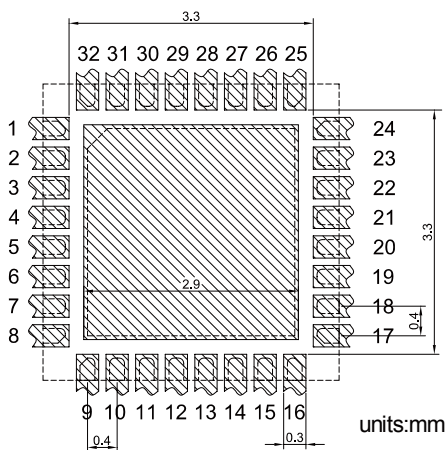

Recommended Land Pattern
Top View

Pin Out

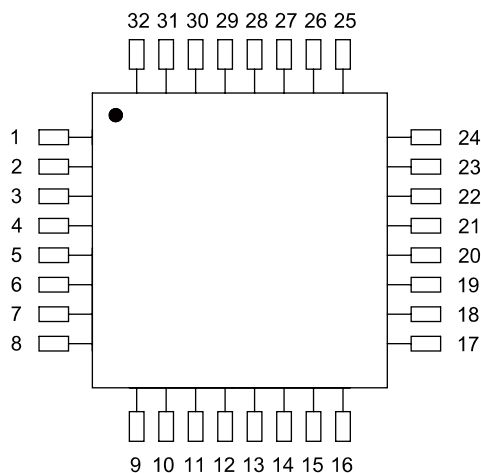

TOP VIEW

Pin #	Connection
1	A Port1
2	GND
3	GND
4	B Port1
5	GND
6	GND
7	C Port1
8	GND
9	GND
10	C Port2 (-6dB,0°)
11	GND
12	C Port3 (-6dB,-90°)
13	GND
14	C Port4 (-6dB,-180°)
15	GND
16	C Port5 (-6dB,-270°)
17	B Port2 (-6dB,0°)
18	GND
19	B Port3 (-6dB,-90°)
20	GND
21	B Port4 (-6dB,-180°)
22	GND
23	B Port5 (-6dB,-270°)
24	GND
25	A Port2 (-6dB,0°)
26	GND
27	A Port3 (-6dB,-90°)
28	GND
29	A Port4 (-6dB,-180°)
30	GND
31	A Port5 (-6dB,-270°)
32	GND
Center Pad	GND

Notes: All dimensions show in millimeters

Yantel Corporation

A1.0

Add : 3F, Building 3, Southern District 2 of Zhongguan Honghualing Industrial Park, Xili, Nanshan, Shenzhen, China
Tel : 86-755-8355-1886 Fax : 86-755-8355-2533

For detailed performance specs & shopping online see Yantel web site : www.yantel-corp.com