

Temperature Compensation Attenuator DC~6GHz 50Ω 2W 1~10dB N3~N10
Part No. Descriptions

***	**	**	**	**	*
Series	Frequency	Attenuation	Temperature Coefficient Code	Metallization Options	Termination Plating Options
TCA,	06	(01 to 10) 1dB to 10 dB	N3 to N10	Planar(no code), W1, W3	(no code)=lead free or (S)=Lead(Pb)

Part No.	Frequency Range (GHz)	Attenuation (dB)	Temperature Coefficient Code	Temperature Coefficient of Attenuation (dB/dB/°C)	Max. VSWR (:1) @1GHz@25°C	Max. Input Power (W)	Attenuation Accuracy (dB)
TCA0601N*	DC-6	1	N3~N9	-0.003~-0.009	1.25	2	±0.5
TCA0602N*	DC-6	2	N3~N10	-0.003~-0.010	1.25	2	±0.5
TCA0603N*	DC-6	3	N3~N10	-0.003~-0.010	1.25	2	±0.5
TCA0604N*	DC-6	4	N3~N10	-0.003~-0.010	1.25	2	±0.5
TCA0605N*	DC-6	5	N3~N10	-0.003~-0.010	1.25	2	±0.5
TCA0606N*	DC-6	6	N3~N10	-0.003~-0.010	1.25	2	±0.5
TCA0607N*	DC-6	7	N3~N10	-0.003~-0.010	1.25	2	±0.5
TCA0608N*	DC-6	8	N3~N10	-0.003~-0.010	1.25	2	±0.5
TCA0609N*	DC-6	9	N3~N10	-0.003~-0.010	1.25	2	±0.5
TCA0610N*	DC-6	10	N3~N10	-0.003~-0.010	1.25	2	±0.5

General Specifications

- Frequency Range DC to 6GHz
- Attenuation 4dB
- Attenuation Accuracy at 25°C ±0.5dB@1GHz
- VSWR 1.25:1 Max. @1GHz, 1.30:1 Max.@2GHz at 25°C
- Nominal Impedance 50 Ohms
- Power Rating 2 Watts CW
- Power Derating 100% @ 125°C
Derates to 0% @ 150°C
- Operating Temperature -55°C to +150°C
- Temperature Coefficient over Operating Temperature Range: See Table Above.
Temperature Coefficient Tolerance: ±0.001dB/dB/°C.
- Substrate: Alumina (Al₂O₃)
- Resistive material: Thick film
- Terminal material: Thick film, Nickel barrier with pure tin plate (lead free) or with tin (Sn90) plate (10% lead contained)
- Protective Coating: Thick film (ethyl acetate)
- Package Outline: See Sheet 3.
- Workmanship: per MIL-PRF-55342.
- RoHS Compliant.
- Electrostatic Discharge Control: per MIL-STD-1686.

Unit Marking dB Value (XX), Direction of Shift (N) and TCA Shift (X).
Legibility and Permanency: per MIL-STD-130.

Quality Assurance

- Sample inspect per ANSI/ASQC Z1.4 general inspection, LEVEL II, AQL = 1.0.
 - 1.1 Visual and mechanical examination for conformance to outline package requirements.
- Select five (5) Units from lot measure attenuation from DC to 6 GHz every 20°C over the temperature range -35°C to +105°C.
 - 2.1 Calculate, using linear regression, the slope of the curve.
 - 2.2 Calculate TCA using the following formula: TCA = Slope / Attenuation @ 25°C.
- Test data required for customer.

Yantel Corporation

Add: 3F, Building 3, Southern District 2 of Zhongguan Honghualing Industrial Park, Xili, Nanshan, Shenzhen, China
Tel: 86-755-8355-1886 Fax: 86-755-8355-2533

For detailed performance specs & shopping online see Yantel web site : www.yantel-corp.com

TCA Response

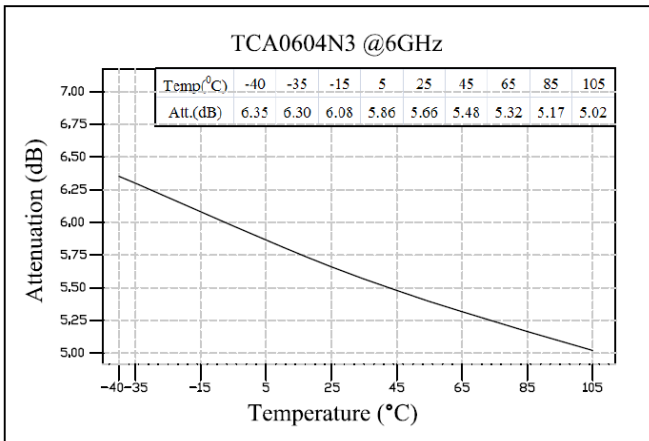
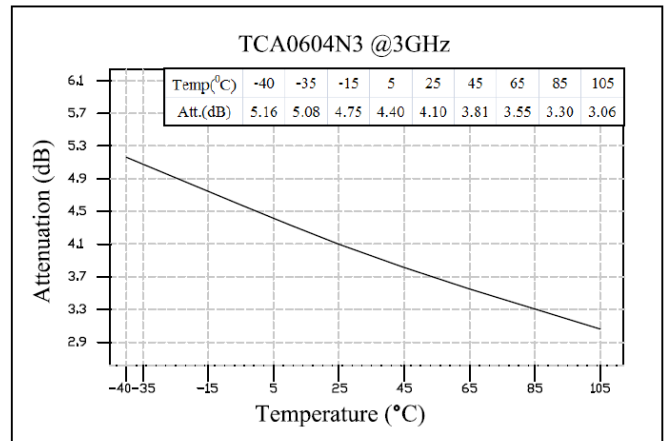
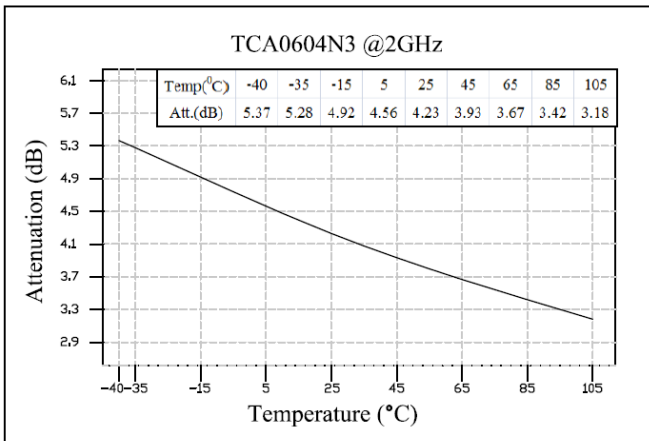
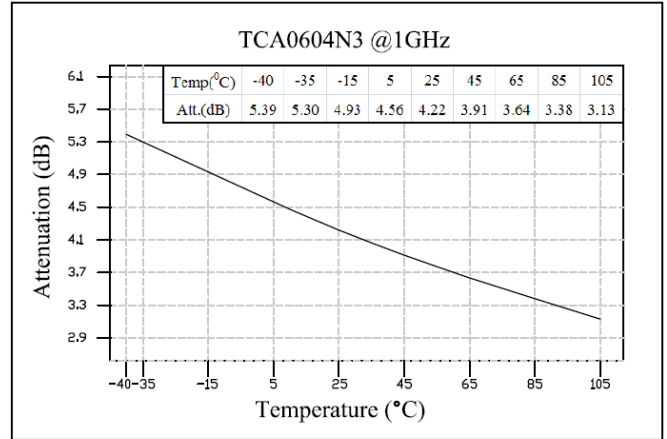
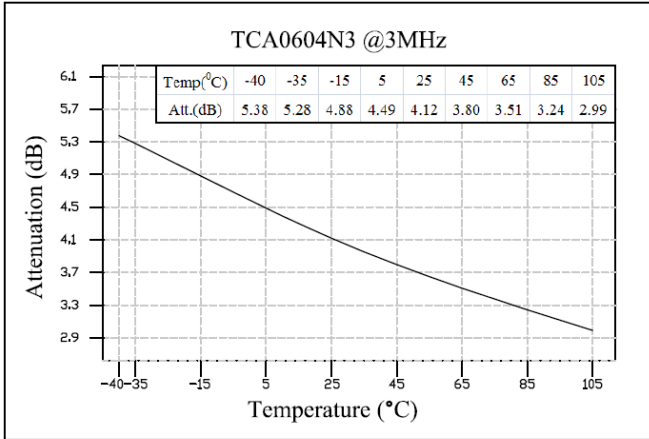

Statistical Table of Attenuation(typ.) VS Temperature

ATT(dB) / Temp(°C)	3MHz	1GHz	2GHz	3GHz
-40	5.38	5.38	5.37	5.16
-35	5.28	5.30	5.28	5.08
-15	4.88	4.93	4.92	4.75
5	4.49	4.56	4.56	4.40
25	4.12	4.22	4.23	4.10
45	3.80	3.91	3.93	3.81
65	3.51	3.64	3.67	3.55
85	3.24	3.38	3.42	3.30
105	2.99	3.13	3.18	3.06

Recommended Layout

All dimensions shown in mm unless stated otherwise

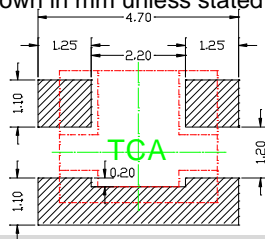

Power Rating & Derating Curve

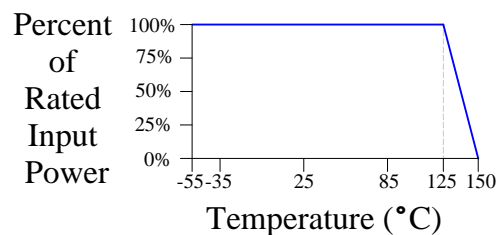

Yantel Corporation

Add: 3F, Building 3, Southern District 2 of Zhongguan Honghualing Industrial Park, Xili, Nanshan, Shenzhen, China

Tel: 86-755-8355-1886 Fax: 86-755-8355-2533

For detailed performance specs & shopping online see Yantel web site : www.yantel-corp.com

Package Outlines

All dimensions shown in mm unless stated otherwise

Note: Dimension tolerance in ± 0.10 otherwise mention. * represents number

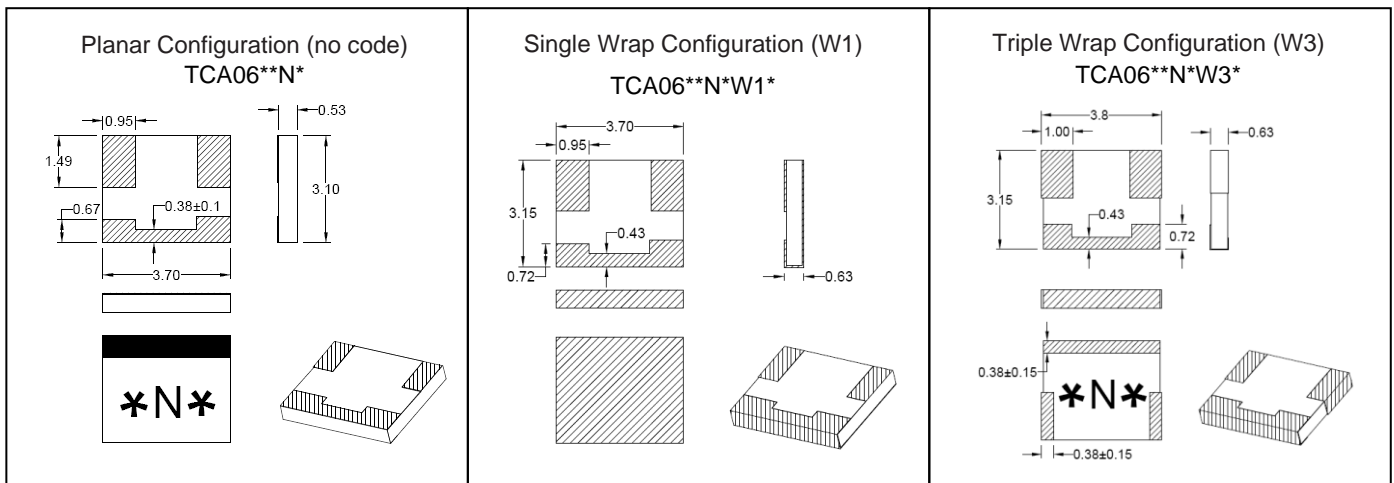

Tape & Reel Drawing

All dimensions shown in mm unless stated otherwise

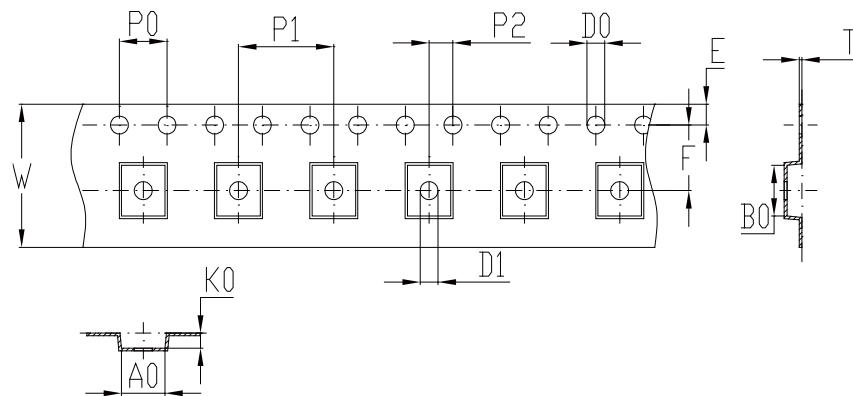

Notice:

- A.10 Sprocket hole pitch cumulative tolerance is 0.2mm.
- B. Carrier camber shall be not more than 1mm per 100mm through a length of 250mm.
- C. All dimensions meet EIA-418-B requirements.
- D. A0 & B0 measured as indicated.
- E. K0 measured from a place on the inside bottom of the pocket to top surface of carrier.
- F. Material: PE 100
- G. Thickness: 0.23 ± 0.05 mm
- H. 1500 units (maximum) / T&R

symbol	A0	B0	K0	P0	P1	P2
spec	3.65 ± 0.1	4.25 ± 0.1	1.25 ± 0.1	4.0 ± 0.1	8.0 ± 0.1	2.0 ± 0.1
symbol	W	T	E	F	D0	D1
spec	12.0 ± 0.3	0.23 ± 0.05	1.75 ± 0.1	5.5 ± 0.1	$\Phi 1.5^{+0.1}_{-0.0}$	$\Phi 1.5$ min

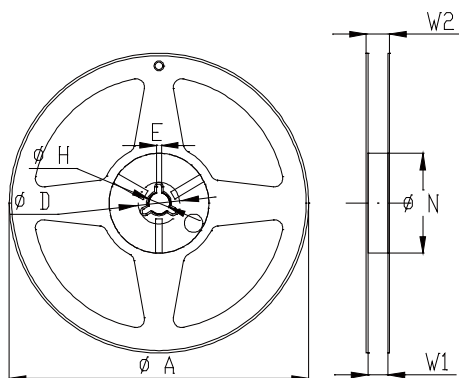

Symbol	Dimensions(mm)
A	$180^{+0/-3}$
N	$60^{+1/-0}$
W1	12.0 ± 0.3
W2	14 ± 1.0
D	25 ± 0.8
H	13 ± 0.2
E	3 ± 0.5



Yantel Corporation

Add: 3F, Building 3, Southern District 2 of Zhongguan Honghualing Industrial Park, Xili, Nanshan, Shenzhen, China

Tel: 86-755-8355-1886 Fax: 86-755-8355-2533

For detailed performance specs & shopping online see Yantel web site : www.yantel-corp.com