

**Temperature Compensation Attenuator DC~6GHz 50Ω 2W 1~10dB N3~N10**
**Part No. Descriptions**

***	**	**	**	**	**	*
<b>Series</b>	<b>Frequency</b>	<b>Attenuation</b>	<b>Temperature Coefficient Code</b>	<b>Metallization Options</b>	<b>Termination Plating Options</b>	
TCA,	06	(01 to 10) 1dB to 10 dB	N3 to N10	Planar(no code), W1, W3	(no code)=lead free or (S)=Lead(Pb)	

Part No.	Frequency Range (GHz)	Attenuation (dB)	Temperature Coefficient Code	Temperature Coefficient of Attenuation (dB/dB/°C)	Max. VSWR (:1) @1GHz@25°C	Max. Input Power (W)	Attenuation Accuracy (dB)
TCA0601N*	DC-6	1	N3~N9	-0.003~ -0.009	1.25	2	±0.5
TCA0602N*	DC-6	2	N3~N10	-0.003~ -0.010	1.25	2	±0.5
TCA0603N*	DC-6	3	N3~N10	-0.003~ -0.010	1.25	2	±0.5
TCA0604N*	DC-6	4	N3~N10	-0.003~ -0.010	1.25	2	±0.5
TCA0605N*	DC-6	5	N3~N10	-0.003~ -0.010	1.25	2	±0.5
TCA0606N*	DC-6	6	N3~N10	-0.003~ -0.010	1.25	2	±0.5
TCA0607N*	DC-6	7	N3~N10	-0.003~ -0.010	1.25	2	±0.5
TCA0608N*	DC-6	8	N3~N10	-0.003~ -0.010	1.25	2	±0.5
TCA0609N*	DC-6	9	N3~N10	-0.003~ -0.010	1.25	2	±0.5
TCA0610N*	DC-6	10	N3~N10	-0.003~ -0.010	1.25	2	±0.5

**General Specifications**

- Frequency Range DC to 6GHz
- Attenuation 6dB
- Attenuation Accuracy at 25°C ±0.5dB@1GHz
- VSWR 1.25:1 Max. @1GHz, 1.30:1 Max. @2GHz at 25°C
- Nominal Impedance 50 Ohms
- Power Rating 2 Watts CW
- Power Derating 100% @ 125°C  
Derates to 0% @ 150°C
- Operating Temperature -55°C to +150°C
- Temperature Coefficient over Operating Temperature Range: See Table Above.  
Temperature Coefficient Tolerance: ±0.001dB/dB/°C.
- Substrate: Alumina (Al<sub>2</sub>O<sub>3</sub>)
- Resistive material: Thick film
- Terminal material: Thick film, Nickel barrier with pure tin plate (lead free) or with tin (Sn90) plate (10% lead contained)
- Protective Coating: Thick film (ethyl acetate)
- Package Outline: See Sheet 3.
- Workmanship: per MIL-PRF-55342.
- RoHS Compliant.
- Electrostatic Discharge Control: per MIL-STD-1686.

**Unit Marking** dB Value (XX), Direction of Shift (N) and TCA Shift (X).  
Legibility and Permanency: per MIL-STD-130.

**Quality Assurance**

- Sample inspect per ANSI/ASQC Z1.4 general inspection, LEVEL II, AQL = 1.0.
  - Visual and mechanical examination for conformance to outline package requirements.
- Select five (5) Units from lot measure attenuation from DC to 6 GHz every 20°C over the temperature range -35°C to +105°C.
  - Calculate, using linear regression, the slope of the curve.
  - Calculate TCA using the following formula: TCA = Slope / Attenuation @ 25°C.
- Test data required for customer.

**Yantel Corporation**

Add: 3F, Building 3, Southern District 2 of Zhongguan Honghualing Industrial Park, Xili, Nanshan, Shenzhen, China

Tel: 86-755-8355-1886 Fax: 86-755-8355-2533

 For detailed performance specs & shopping online see Yantel web site : [www.yantel-corp.com](http://www.yantel-corp.com)

TCA Response

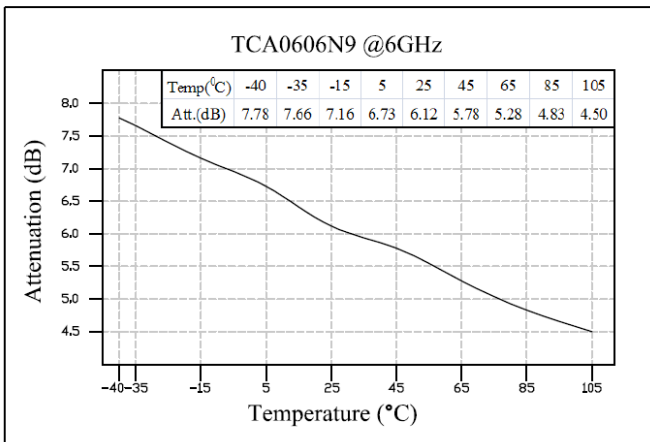
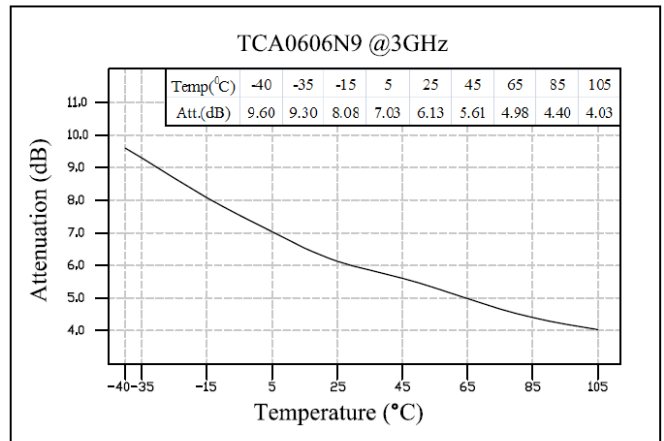
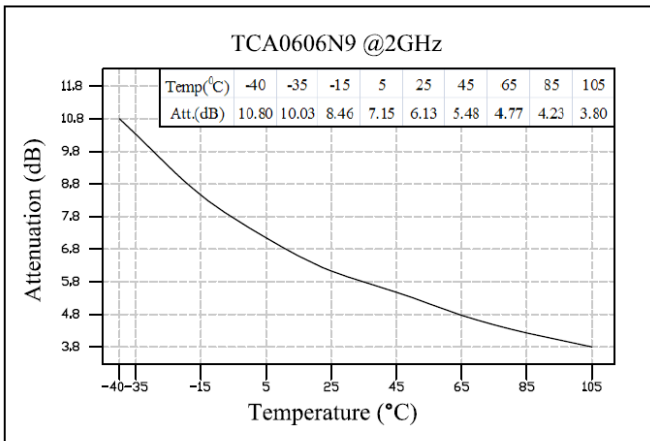
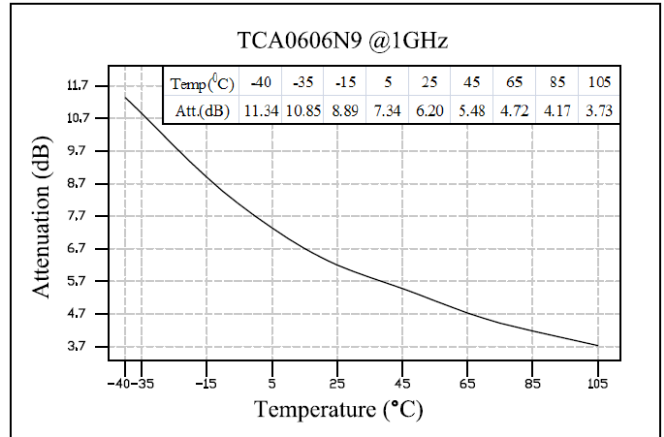
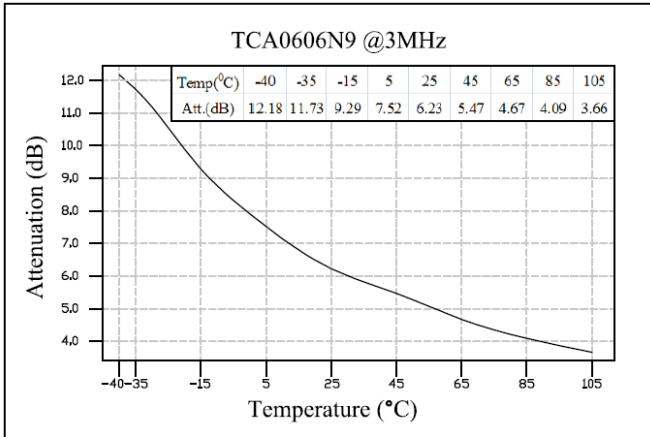

Temp(°C) \ ATT(dB)	3MHz	1GHz	2GHz	3GHz
-40	12.18	11.34	10.80	9.60
-35	11.73	10.85	10.03	9.30
-15	9.29	8.89	8.46	8.08
5	7.52	7.34	7.15	7.03
25	6.23	6.20	6.13	6.13
45	5.47	5.48	5.48	5.61
65	4.67	4.72	4.77	4.98
85	4.09	4.17	4.23	4.40
105	3.66	3.73	3.80	4.03

Recommended Layout

All dimensions shown in mm unless stated otherwise

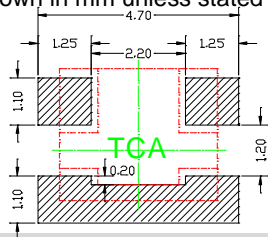

Power Rating & Derating Curve

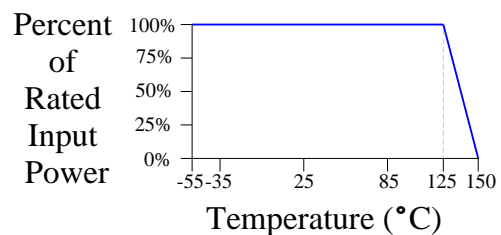

Yantel Corporation

Add: 3F, Building 3, Southern District 2 of Zhongguan Honghualing Industrial Park, Xili, Nanshan, Shenzhen, China

Tel: 86-755-8355-1886 Fax: 86-755-8355-2533

For detailed performance specs & shopping online see Yantel web site : [www.yantel-corp.com](http://www.yantel-corp.com)

### Package Outlines

All dimensions shown in mm unless stated otherwise

Note: Dimension tolerance in  $\pm 0.10$  otherwise mention. \* represents number

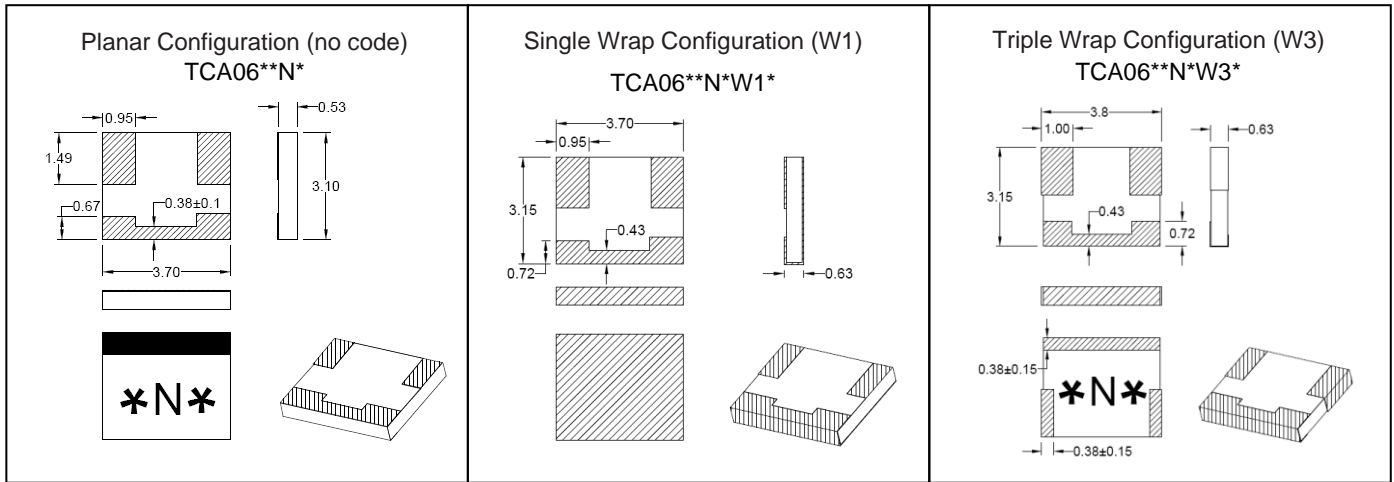

### Tape & Reel Drawing

All dimensions shown in mm unless stated otherwise

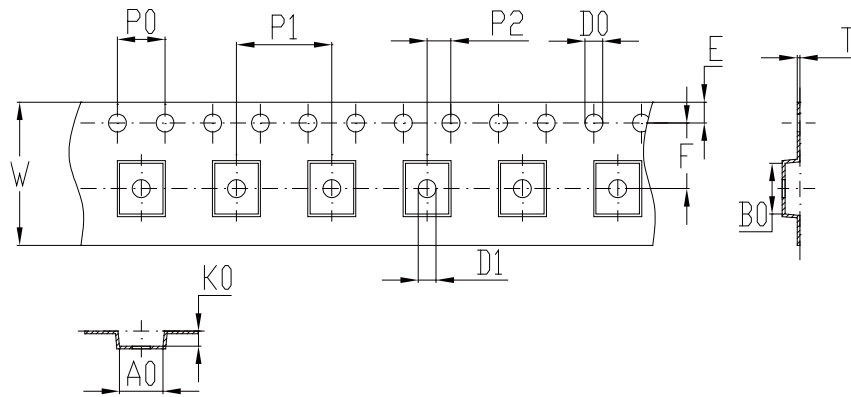

Notice:

- A.10 Sprocket hole pitch cumulative tolerance is 0.2mm.
- B. Carrier camber shall be not more than 1mm per 100mm through a length of 250mm.
- C. All dimensions meet EIA-418-B requirements.
- D. A0 & B0 measured as indicated.
- E. K0 measured from a place on the inside bottom of the pocket to top surface of carrier.
- F. Material: PE 100
- G. Thickness:  $0.23 \pm 0.05$ mm
- H. 1500 units (maximum) / T&R

symbol	A0	B0	K0	P0	P1	P2
spec	$3.65 \pm 0.1$	$4.25 \pm 0.1$	$1.25 \pm 0.1$	$4.0 \pm 0.1$	$8.0 \pm 0.1$	$2.0 \pm 0.1$
symbol	W	T	E	F	D0	D1
spec	$12.0 \pm 0.3$	$0.23 \pm 0.05$	$1.75 \pm 0.1$	$5.5 \pm 0.1$	$\Phi 1.5^{+0.1}_{-0.0}$	$\Phi 1.5$ min

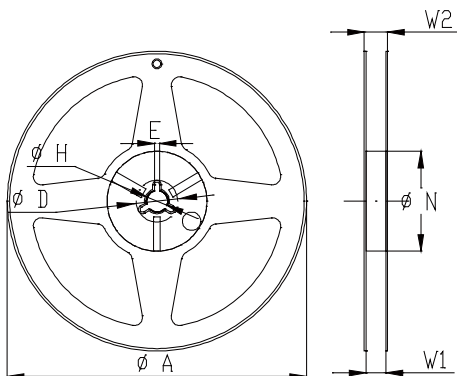

Symbol	Dimensions(mm)
A	$180^{+0/-3}$
N	$60^{+1/-0}$
W1	$12.0 \pm 0.3$
W2	$14 \pm 1.0$
D	$25 \pm 0.8$
H	$13 \pm 0.2$
E	$3 \pm 0.5$



#### Yantel Corporation

Add: 3F, Building 3, Southern District 2 of Zhongguan Honghualing Industrial Park, Xili, Nanshan, Shenzhen, China

Tel: 86-755-8355-1886 Fax: 86-755-8355-2533

For detailed performance specs & shopping online see Yantel web site : [www.yantel-corp.com](http://www.yantel-corp.com)