

**Part No. Description**

TCA      \*\*                      \*\*                      \*\*

Frequency    Attenuation    Temperature coefficient code

Model	Frequency Range (GHz)	Attenuation (dB)	Temperature Coefficient Code	Temperature Coefficient of Attenuation (dB/dB/°C)	Max. VSWR (:1) @1GHz@25°C	Max. Input Power (W)	Attenuation Accuracy (dB)
TCA0601N*	DC-6	1	N3~N9	-0.003~ -0.009	1.2	2	±0.3
TCA0602N*	DC-6	2	N3~N10	-0.003~ -0.010	1.2	2	±0.3
TCA0603N*	DC-6	3	N3~N10	-0.003~ -0.010	1.2	2	±0.3
TCA0604N*	DC-6	4	N3~N10	-0.003~ -0.010	1.2	2	±0.5
TCA0605N*	DC-6	5	N3~N10	-0.003~ -0.010	1.2	2	±0.5
TCA0606N*	DC-6	6	N3~N10	-0.003~ -0.010	1.2	2	±0.5
TCA0607N*	DC-6	7	N3~N10	-0.003~ -0.010	1.2	2	±0.5
TCA0608N*	DC-6	8	N3~N10	-0.003~ -0.010	1.2	2	±0.5
TCA0609N*	DC-6	9	N3~N10	-0.003~ -0.010	1.2	2	±0.5
TCA0610N*	DC-6	10	N3~N10	-0.003~ -0.010	1.2	2	±0.5

**General Specifications**

- Frequency Range DC to 6GHz
- Attenuation 9dB
- Attenuation Accuracy at 25°C ±0.5dB@1GHz
- VSWR 1.2:1 Max. @1GHz at 25°C
- Nominal Impedance 50 Ohms
- Power Rating 2 Watts CW
- Power Derating 100% @ 85°C  
Derates to 0% @ 150°C
- Operating Temperature -55°C to +150°C
- Temperature Coefficient over Operating Temperature Range: See Table Above.  
Temperature Coefficient Tolerance:+0.001dB/dB/°C.
- Package Outline: See Sheet 2.
- Workmanship: per MIL-PRF-55342.
- RoHS Compliant Lead Free Silver over Nickel Plating.
- Electrostatic Discharge Control: per MIL-STD-1686.

**Unit Marking** dB Value (XX), Direction of Shift (N) and TCA Shift (X).

Legibility and Permanency: per MIL-STD-130.

**Quality Assurance**

- Sample inspect per ANSI/ASQC Z1.4 general inspection, LEVEL II, AQL = 1.0.
  - 1.1 Visual and mechanical examination for conformance to outline package requirements.
- Select five (5) Units from lot measure attenuation from DC to 6GHz every 20°C over the temperature range -55°C to +125°C.
  - 2.1 Calculate, using linear regression, the slope of the curve.
  - 2.2 Calculate TCA using the following formula: TCA = Slope / Attenuation @ 25°C.
- Test data required for customer.

**Yantel Corporation**

Add:2nd Floor,Building 2,Gaofa Technology Park,Longjing,Nanshan,Shenzhen,China.PC 518055

Tel: 86-755-8355-1886 Fax: 86-755-8355-2533

 For detailed performance specs & shopping online see Yantel web site : [www.yantel-corp.com](http://www.yantel-corp.com)

TCA Response

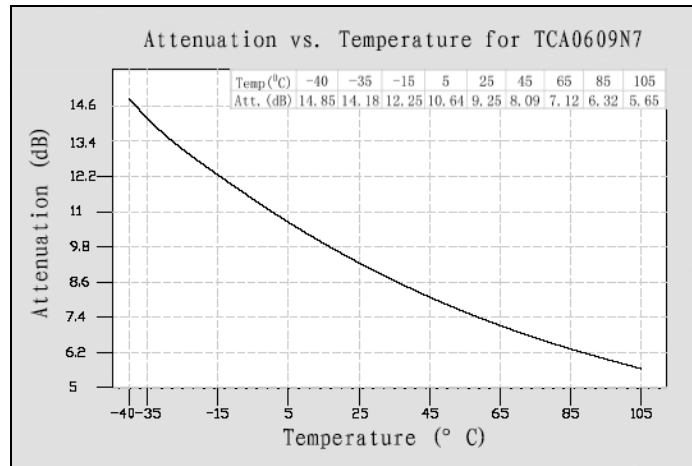

Package Outlines

All dimensions shown in mm unless stated otherwise

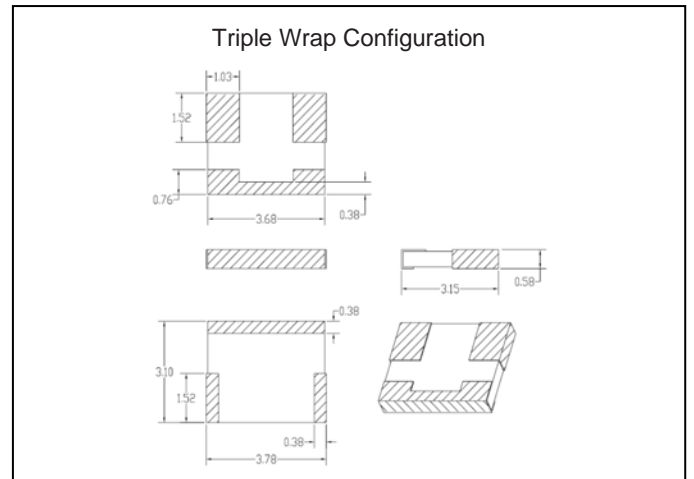
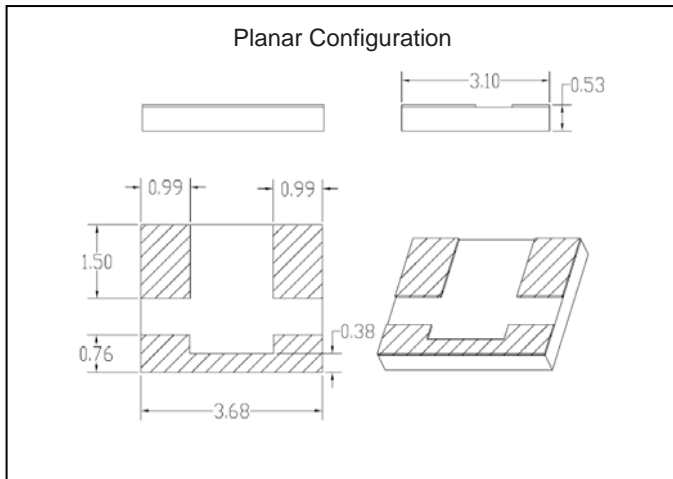

Tape & Reel

All dimensions shown in mm unless stated otherwise

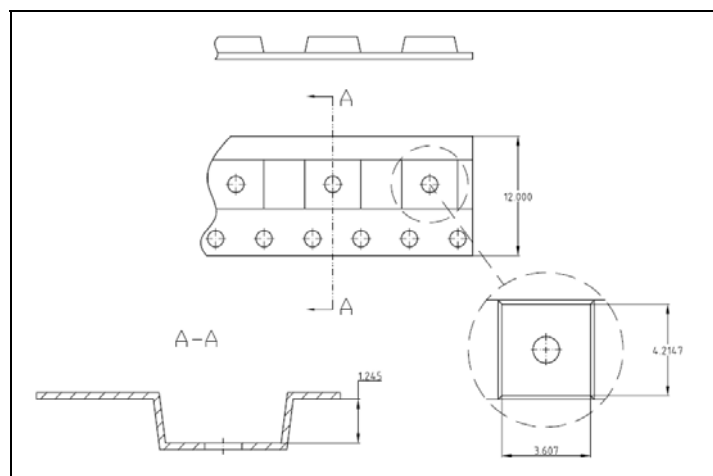

Yantel Corporation

Add: 2nd Floor, Building 2, Gaofa Technology Park, Longjing, Nanshan, Shenzhen, China. PC 518055

Tel: 86-755-8355-1886 Fax: 86-755-8355-2533

For detailed performance specs & shopping online see Yantel web site : [www.yantel-corp.com](http://www.yantel-corp.com)