

## Miniature Variable Attenuator

### VAD Series

- ◆ DC to 2.5GHz
- ◆ 0 to 1 dB in 0.2 dB Step
- ◆ 125 mW
- ◆ Resin DIP package

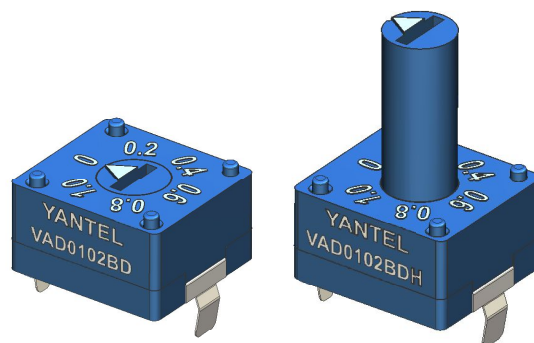

## Features

- DIP package, ultra-small size, able to be mounted or soldered on the PCB
- Wide frequency range
- Low reflection coefficient
- Low insertion loss, high attenuation accuracy.
- Replaceable of digital attenuator, easier to fix and adjust
- At least 360 times (60 circles, 6 times as a circle) tuning operation
- Compared with digital attenuators, zero distortion, no extra IP3, lower noise, higher reliability
- High performance, competitive price.
- Customized attenuation values available.
- Wide attenuation range.
- Power handling: 125mW
- 0.2dB step
- 6 attenuation values

## Specifications

Frequency Range	DC to 2.5GHz
Attenuation	0 to 1 dB
Step Value	0.2dB
Insertion loss at 0 dB	DC to 2 GHz 0.4dB 2 GHz to 2.5GHz 1.0dB
Nominal Impedance	75 Ohm
Average Power	125 mW
Operating Temperature	-40℃ to +105℃

0.2dB ~ 1dB

FREQ. RANGE (GHz)	Attenuation Accuracy(dB)
DC to 2	1.0
2 to 2.5	1.5

FREQ. RANGE (GHz)	VSWR:1
DC to 2.5	1.40

## Characteristic

The testing curves of VAD0102B

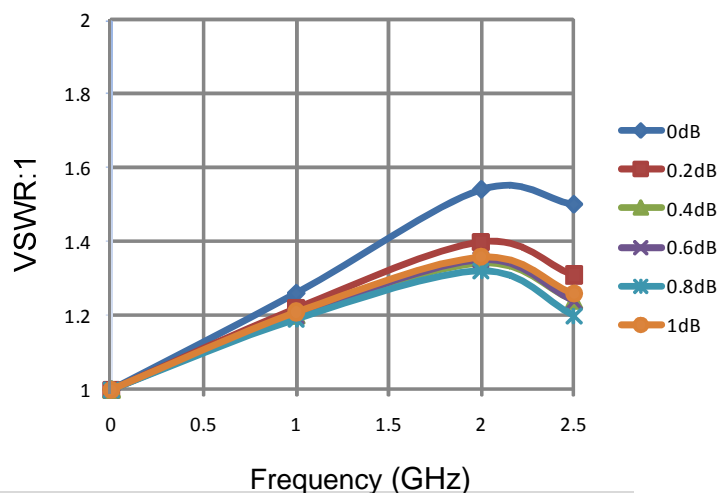
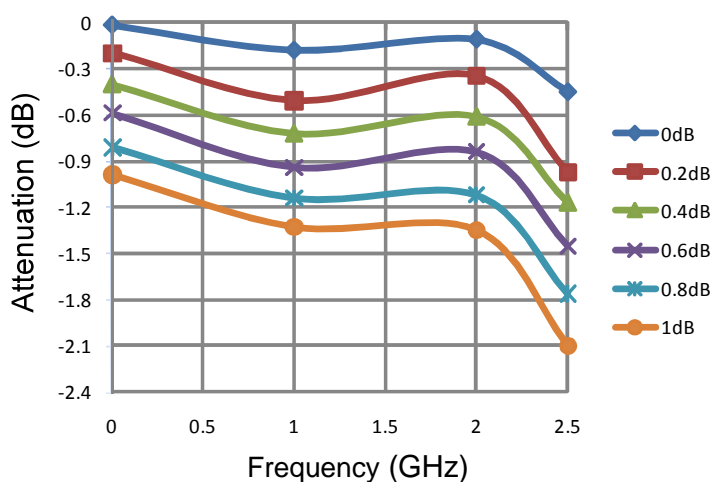

Note: This product cannot withstand high temperature over 200℃, therefore lead free or lead reflow soldering is not suitable.

Otherwise, its performance and reliability would be greatly damaged. Wave soldering should be adopted for this product.

Please click the link below to obtain the wave soldering profile for reference:

[http://www.yantel-corp.com/asp\\_bin/downfile/201511/Wave%20Soldering%20Profile.pdf](http://www.yantel-corp.com/asp_bin/downfile/201511/Wave%20Soldering%20Profile.pdf)

**Typical Performance (-40°C, 25°C, 85°C, 105°C: DC-2.5 GHz)**

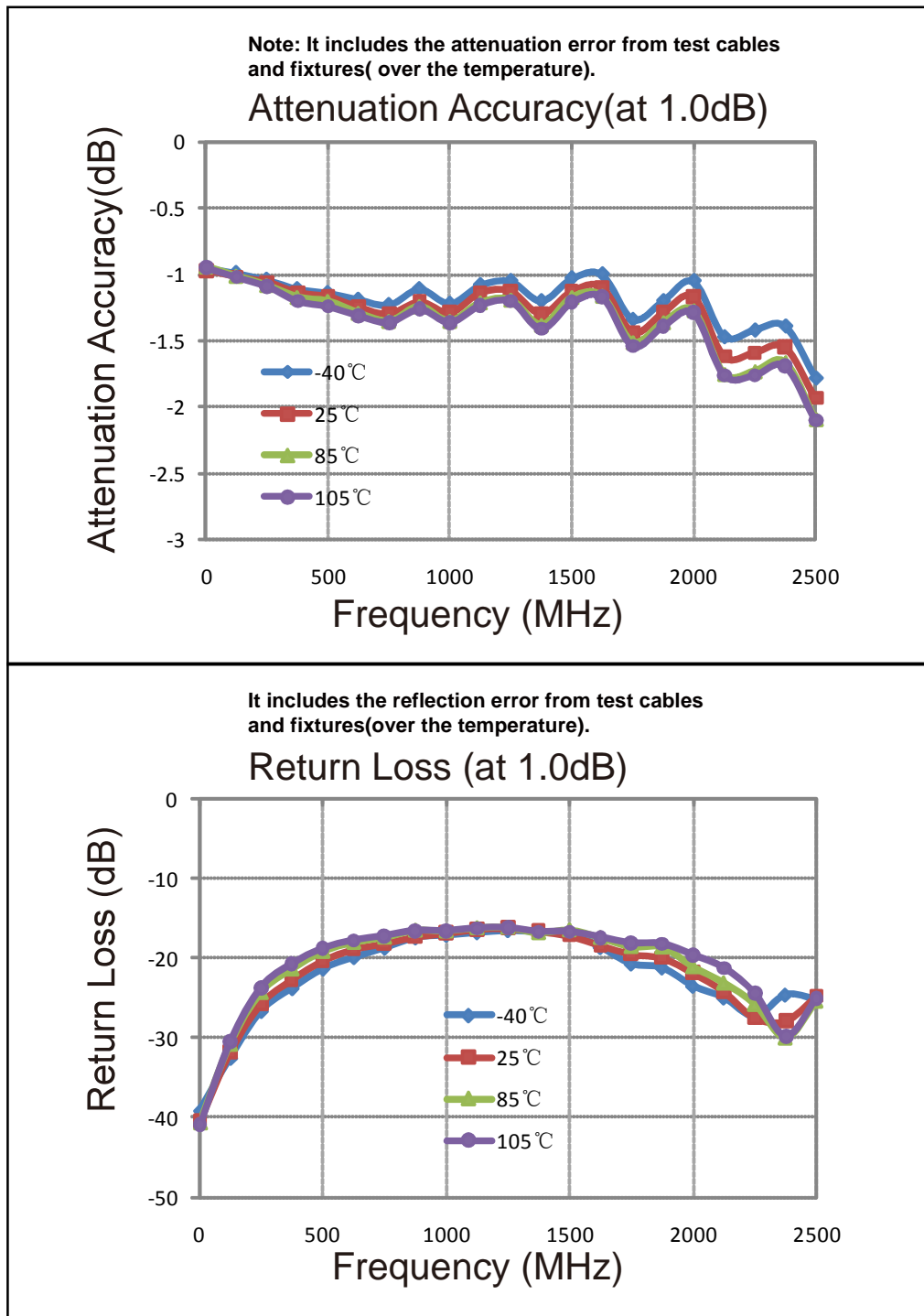

## Model Description

VAD                    \*\*                    \*\*                    \*                    \*                    \*  
                          Attenuation Range    Step value           Impedance           Package           shaft

e.g.: VAD0102

**Attenuation Range:** 01 represent 0 ~ 1dB

**Step value:** 02 represent step value 0.2 dB,

**Impedance:** (-B) represents 75Ω impedance, (no code) represents 50Ω impedance.

**Package:** (-D) represents DIP package, (no code) represents SMD package.

**shaft:** (-H) represents a handling shaft, (no code) represents without handling shaft.

## Package Outlines(mm)

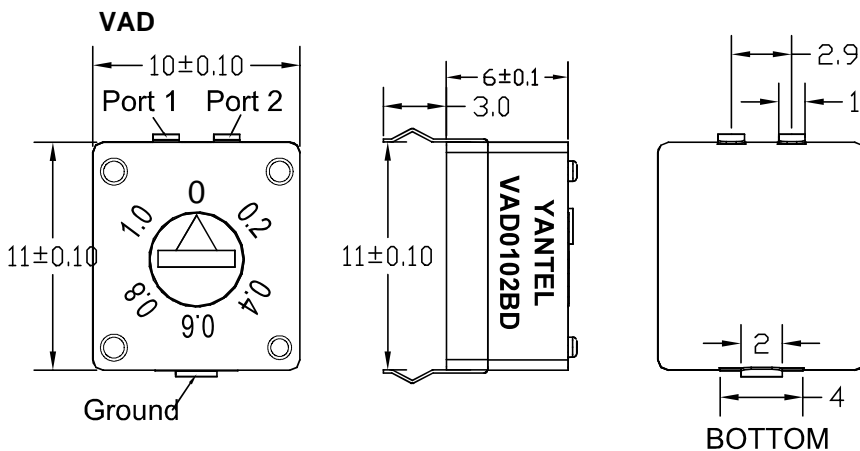

## Recommended PCB Layout

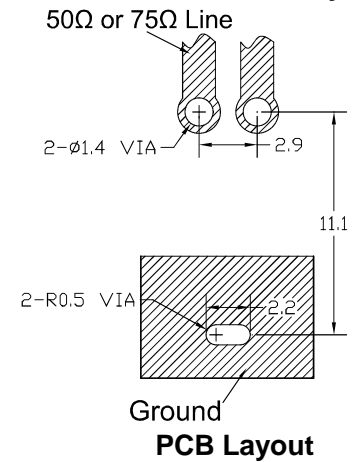

## VAD-with handling shaft

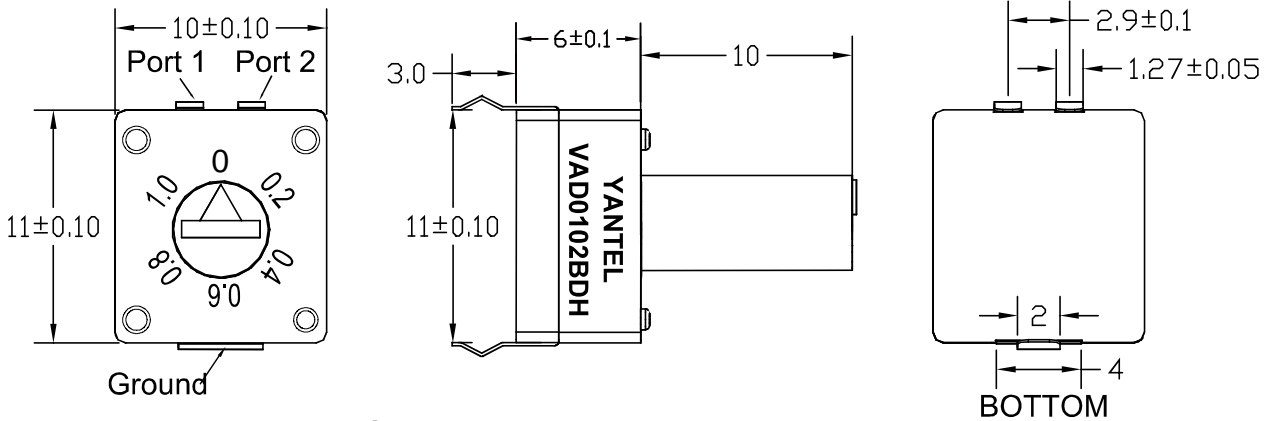

## Tape and Reel Drawing

