

Miniature Variable Attenuator VAD Series

- ◆ DC to 2.5 GHz
- ◆ 0 to 5 dB in 1 dB Step
- ◆ 125 mW
- ◆ Resin DIP package

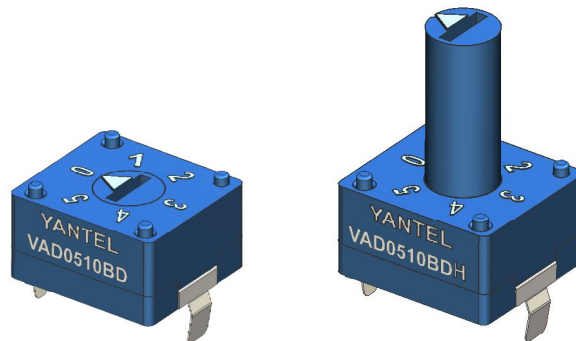

Features

- DIP package, ultra-small size, able to be mounted or soldered on the PCB
- Wide frequency range
- Low reflection coefficient
- Low insertion loss, high attenuation accuracy.
- Replaceable of digital attenuator, easier to fix and adjust
- At least 360 times (60 circles, 6 times as a circle) tuning operation
- Compared with digital attenuators, zero distortion, no extra IP3, lower noise, higher reliability
- High performance, competitive price.
- Customized attenuation values available.
- Wide attenuation range.
- Power handling: 125mW
- 1 dB step
- 6 attenuation values

Specifications

Frequency Range	DC to 2.5GHz
Attenuation	0 to 5 dB
Step Value	1 dB
Insertion loss at 0dB	DC to 2GHz 0.4dB 2 GHz to 2.5GHz 1.0dB
Nominal Impedance	75 Ohm
Average Power	125 mW
Operating Temperature	-40°C to +105°C

1dB~5dB

FREQ. RANGE (GHz)	Attenuation Accuracy(dB)
DC to 1	±0.35
1 to 2	1.1
2 to 2.5	2.1

FREQ. RANGE (GHz)	VSWR:1
DC to 2.5	1.40

Characteristic

The testing curves of VAD0510B

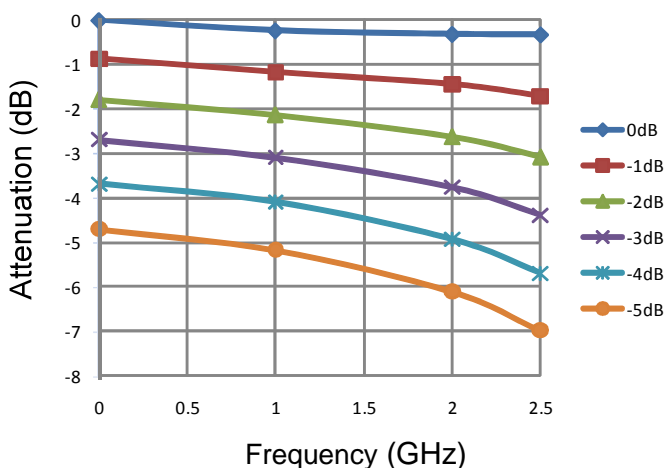

Note: This product cannot withstand high temperature over 200°C, therefore lead free or lead reflow soldering is not suitable.

Otherwise, its performance and reliability would be greatly damaged.

Wave soldering should be adopted for this product.

Please click the link below to obtain the wave soldering profile for reference:

http://www.yantel-corp.com/asp_bin/download/201511/Wave%20Soldering%20Profile.pdf

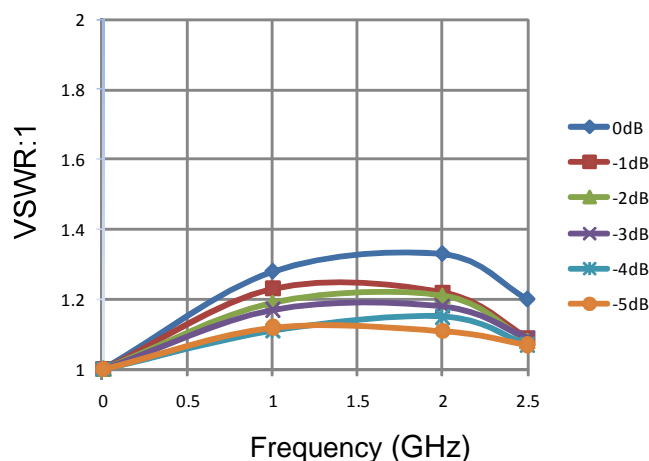

Yantel Corporation

Rev A2.1

Add:3F, Building 3, Southern District 2 of ZhongGuan Honghualing Industrial Park, Xili, Nanshan, Shenzhen, China

Tel: 86-755-8355-1886 Fax: 86-755-8355-2533

For detailed performance specs & shopping online see Yantel web site : www.yantel-corp.com

Typical Performance (-40°C, 25°C, 85°C,105°C: DC-2.5 GHz)

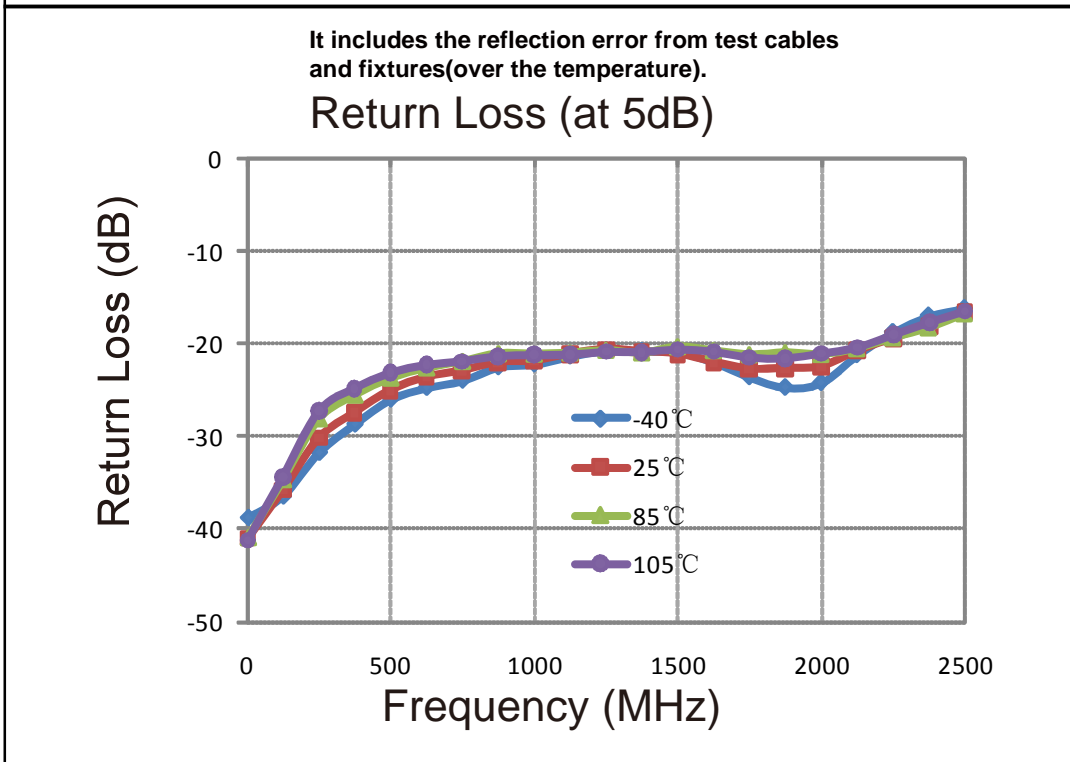
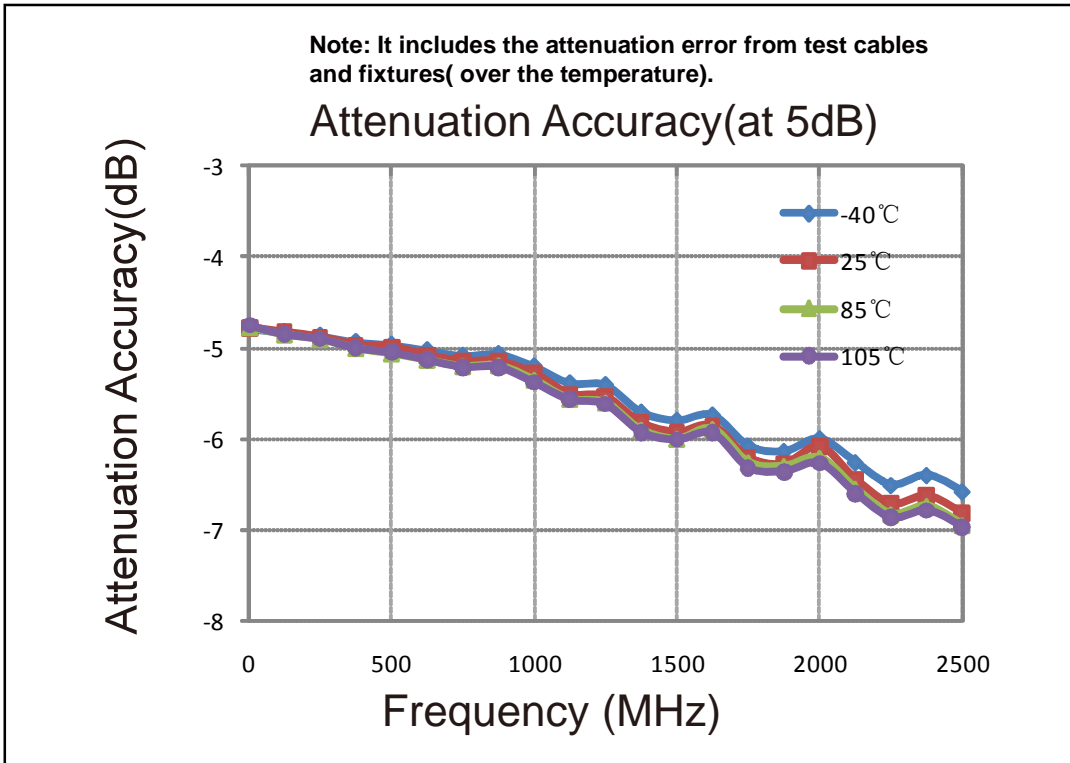

Model Description

VAD ** ** * * *
 Attenuation Range Step value Impedance Package shaft

e.g.: VAD0102

Attenuation Range: 01 represent 0 ~ 1dB

Step value: 02 represent step value 0.2 dB,

Impedance: (-B) represents 75Ω impedance, (no code) represents 50Ω impedance.

Package: (-D) represents DIP package, (no code) represents SMD package.

shaft: (-H) represents a handling shaft, (no code) represents without handling shaft.

Package Outlines(mm)

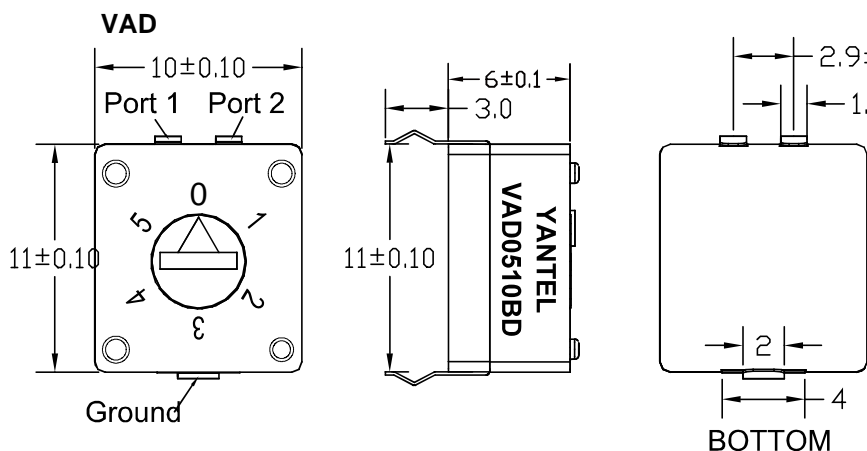

Recommended PCB Layout

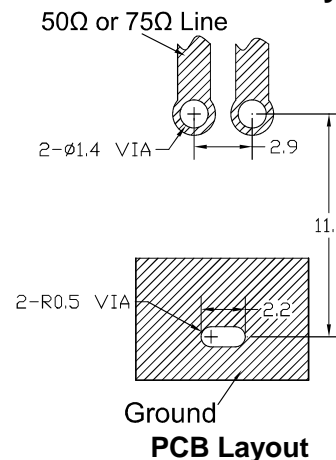

VAD-with handling shaft

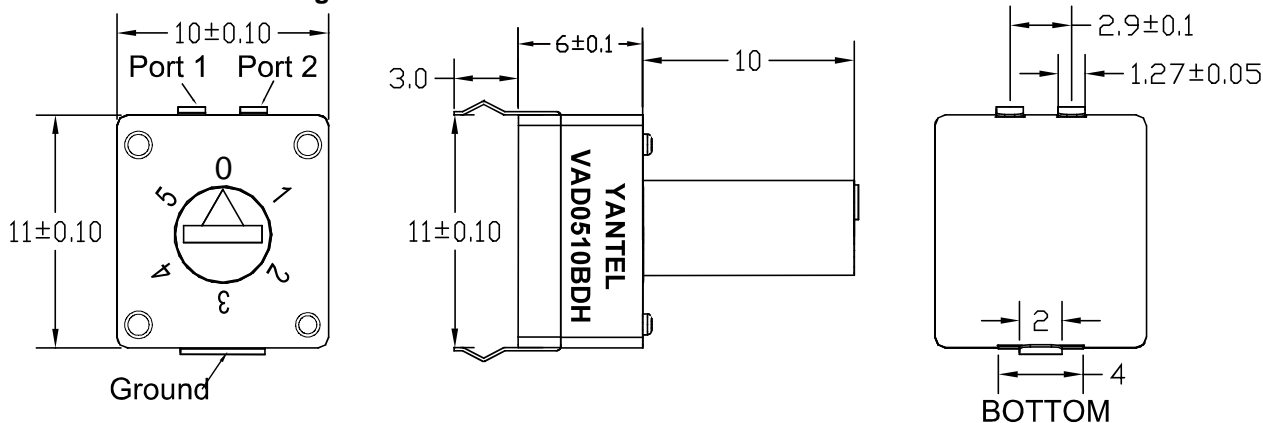

Tape and Reel Drawing

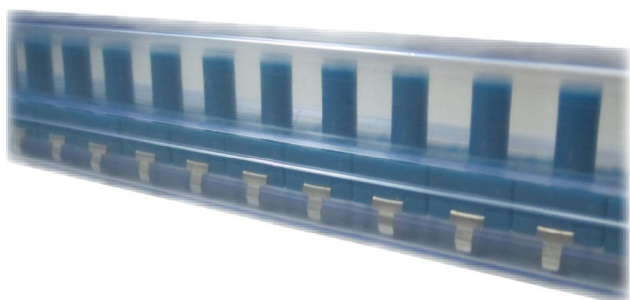

Application Note:

0~XXdB (>5dB) 1dB/step

2 pieces of VAD

The total attenuation range can meet XXdB(such as 17 dB or 20dB)

Example 1:

You need 2 sets(pieces) of VAD,it can meet the attenuation range:0 to 17 dB by 1dB/step

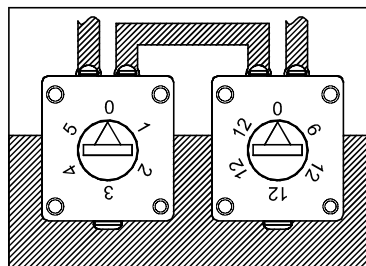
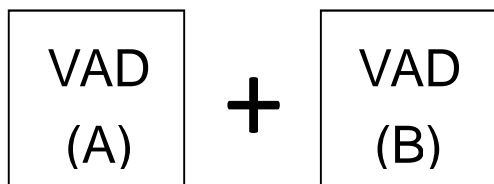

VAD(A): 0,1,2,3,4,5dB;

VAD(B): 0, 6,12,12,12,12dB;

You can get the attenuation value are:A+B=M dB

Application 1: When A=0, 1, 2, 3, 4, or 5dB, B=0dB, then M=A+B=0, 1, 2, 3, 4 or 5dB;

Application 2: When A=0, 1, 2, 3, 4, or 5dB, B=6dB, then M=A+B=6, 7, 8, 9, 10 or 11dB;

Application 3: When A=0, 1, 2, 3, 4, or 5dB, B=12dB, then M=A+B=12, 13, 14, 15, 16 or 17dB;

Example 2:

You need 2 sets(pieces) of VAD,it can meet the attenuation range:0 to 20 dB by 1dB/step

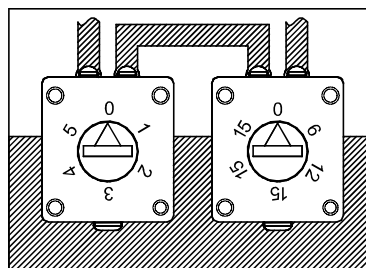
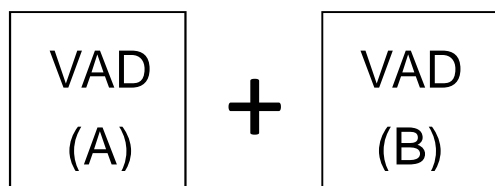

VAD(A): 0,1,2,3,4,5dB;

VAD(B): 0, 6,12,15,15,15dB;

You can get the attenuation value are:A+B=M dB

Application 1: When A=0, 1, 2, 3, 4, or 5dB, B=0dB, then M=A+B=0, 1, 2, 3, 4 or 5dB;

Application 2: When A=0, 1, 2, 3, 4, or 5dB, B=6dB, then M=A+B=6, 7, 8, 9, 10 or 11dB;

Application 3: When A=0, 1, 2, 3, 4, or 5dB, B=12dB, then M=A+B=12, 13, 14, 15, 16 or 17dB;

Application 4: When A=0, 1, 2, 3, 4, or 5dB, B=15dB, then M=A+B=15, 16, 17, 18, 19 or 20dB;

Recommended PCB Layout

