

Miniature Variable Attenuator VAD Series

- ◆ DC to 1.2GHz
- ◆ 0 to 15 dB in 3 dB Step
- ◆ 125 mW
- ◆ Resin DIP package

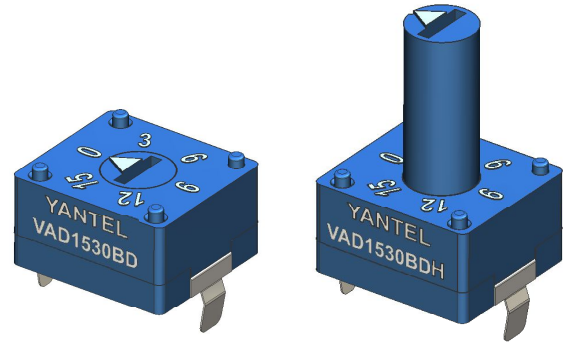

Features

- DIP package, ultra-small size, able to be mounted or soldered on the PCB
- Wide frequency range
- Low reflection coefficient
- Low insertion loss, high attenuation accuracy.
- Replaceable of digital attenuator, easier to fix and adjust
- At least 360 times (60 circles, 6 times as a circle) tuning operation
- Compared with digital attenuators, zero distortion, no extra IP3, lower noise, higher reliability
- High performance, competitive price.
- Customized attenuation values available.
- Wide attenuation range.
- Power handling: 125mW
- 3.0dB step
- 6 attenuation values

Note: This product cannot withstand high temperature over 200°C, therefore lead free or lead reflow soldering is not suitable. Otherwise, its performance and reliability would be greatly damaged. Wave soldering should be adopted for this product. Please click the link below to obtain the wave soldering profile for reference:
http://www.yantel-corp.com/asp_bin/downfile/201511/Wave%20Soldering%20Profile.pdf

Characteristic

The testing curves of VAD1530BD

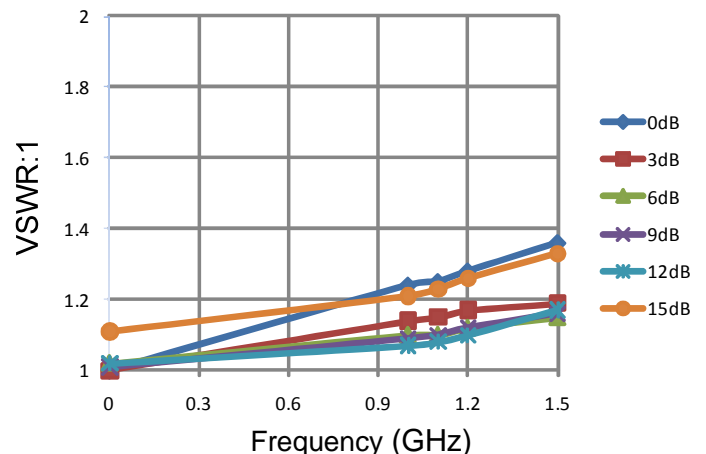
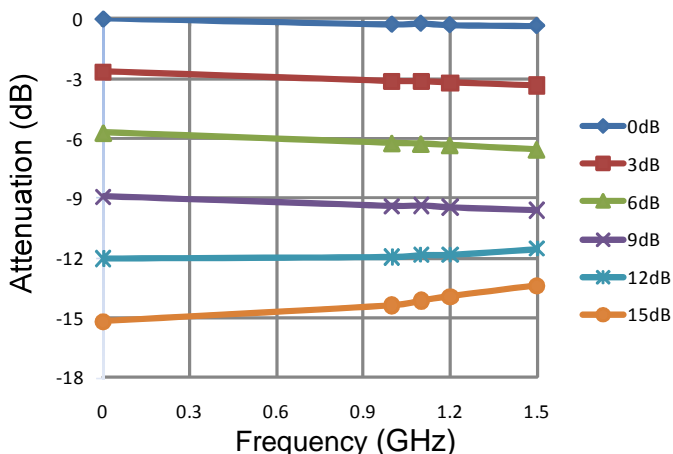

Specifications

Frequency Range	DC to 1.2 GHz
Attenuation	0 to 15 dB
Step Value	3 dB
Insertion loss at 0dB	DC to 1.2 GHz 0.4dB
Nominal Impedance	75 Ohm
Average Power	125 mW
Operating Temperature	-40°C to +105°C

0 to 12 dB

FREQ. RANGE (GHz)	Attenuation Accuracy(dB)
DC to 1.2	±0.5

15 dB

FREQ. RANGE (GHz)	Attenuation Accuracy(dB)
DC to 1.0	±0.8
1.0 to 1.2	-1.1

0 to 15 dB

FREQ. RANGE (GHz)	VSWR:1
DC to 1.2	1.35

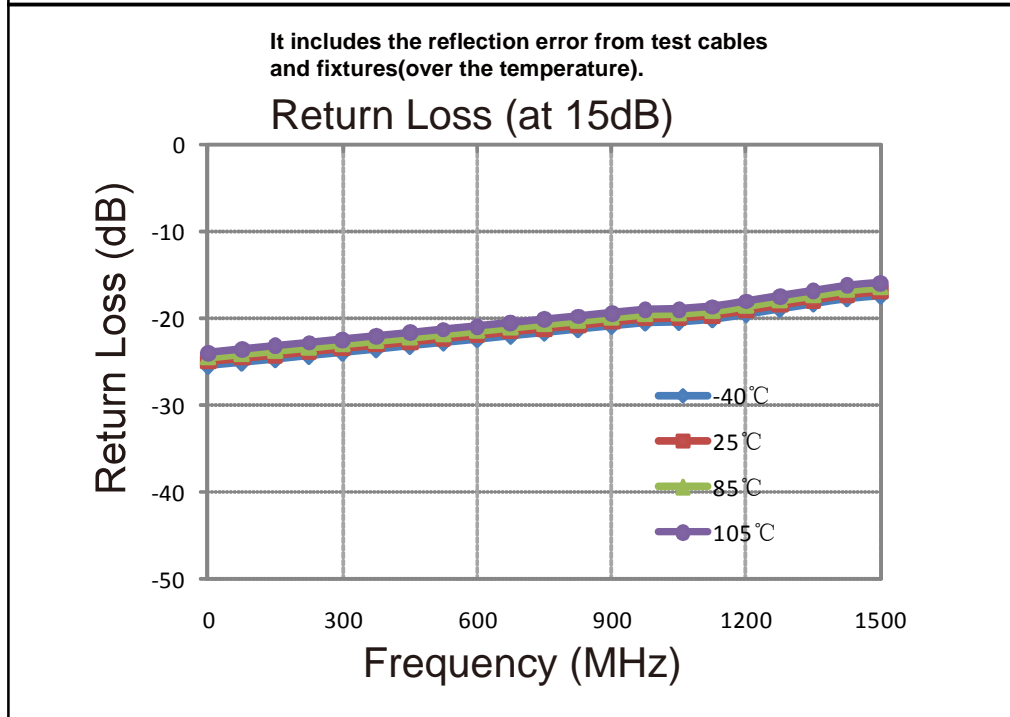
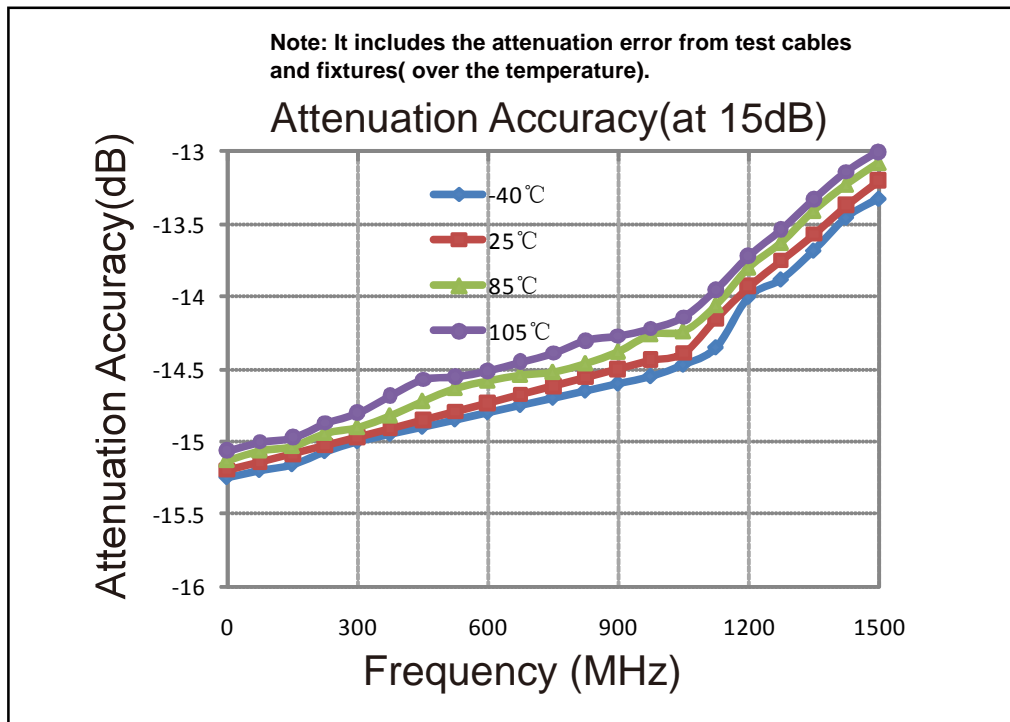
Typical Performance (-40°C, 25°C, 85°C, 105°C: DC-2.5 GHz)

Model Description

VAD ** ** * * *
 Attenuation Range Step value Impedance Package shaft

e.g.: VAD0102

Attenuation Range: 01 represent 0 ~ 1dB

Step value: 02 represent step value 0.2 dB,

Impedance: (-B) represents 75Ω impedance, (no code) represents 50Ω impedance.

Package: (-D) represents DIP package, (no code) represents SMD package.

shaft: (-H) represents a handling shaft, (no code) represents without handling shaft.

Package Outlines(mm)

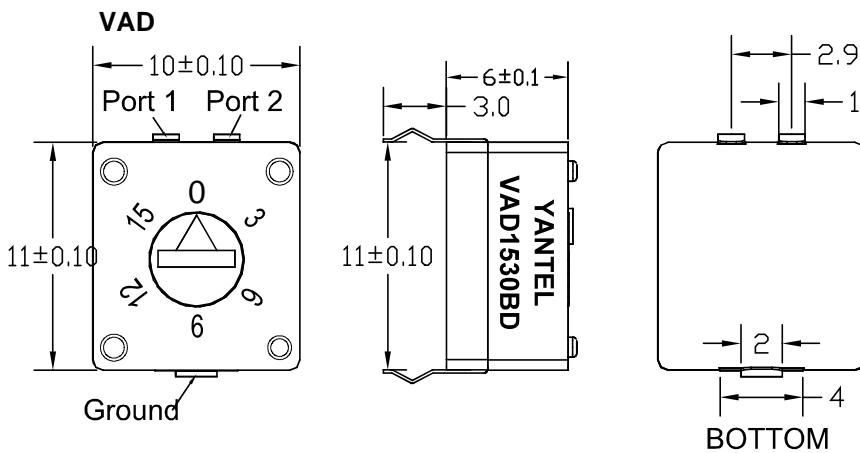

Recommended PCB Layout

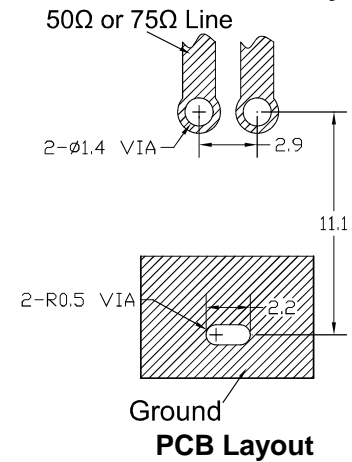

VAD-with handling shaft

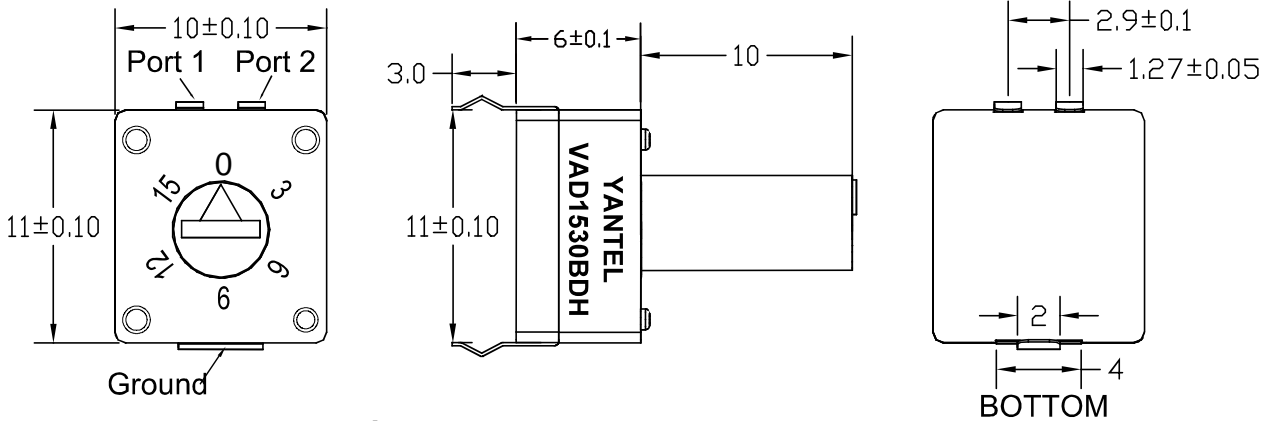

Tape and Reel Drawing

