

Manual Step Attenuator

- ◆ DC to 3GHz
- ◆ 0 to 27dB in 3dB Step
- ◆ 5 Watt
- ◆ Connector Type:SMA,N,TNC,F,BNC etc. available.

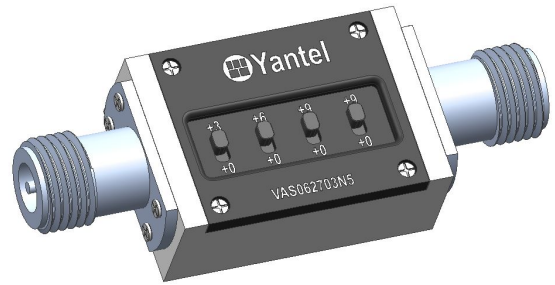

Features

- Using advanced microstrip technology, ultra-small size
- Attenuation values are adjustable in a power-on state, no sudden big reflection.
It adopts an innovative technology, and thus it eliminates sudden big reflection in attenuators when attenuation is being adjusted, preventing the preliminary RF circuit from being burnt, and keeping the system stable
- Step values: 3dB, 6dB,9dB, 9dB
- 10 attenuation values
- High attenuation accuracy, low insertion loss
- High adjustment accuracy
- Low cost – High Performance
- Adjusting the transmitting (receiving) distance of RF signal precisely. Adjusting accuracy is limited to 5cm.
- Switch repeatability avg.> 10000 operations (5000 cycles) per switch.
- PC(Polycarbonate) Switch, operating temperature of 120°C is available.
- Attenuation values are adjustable in a power-on state, test data can be read continuously, no interruption.

Specifications

Frequency Range	DC to 3GHz
Attenuation	0 to 27dB
Step Value	3dB
Insertion loss at 0dB (typ.)	0.50dB at 1 GHz 0.90dB at 2 GHz 1.30dB at 3 GHz

Attenuation Accuracy (typ.)

-1 to 0dB at 1GHz
±0.5dB at 2GHz
0 to +1.5dB at 3GHz

Nominal Impedance 50 Ohm

Average Power 5 Watt

Operating Temperature -40°C to +85°C

Freq. Range (GHz)	VSWR(:1)	
	Typ.	Max.
DC to 3	1.25	1.45

Characteristic

For example the testing curves of VAS062703N52 of 27dB

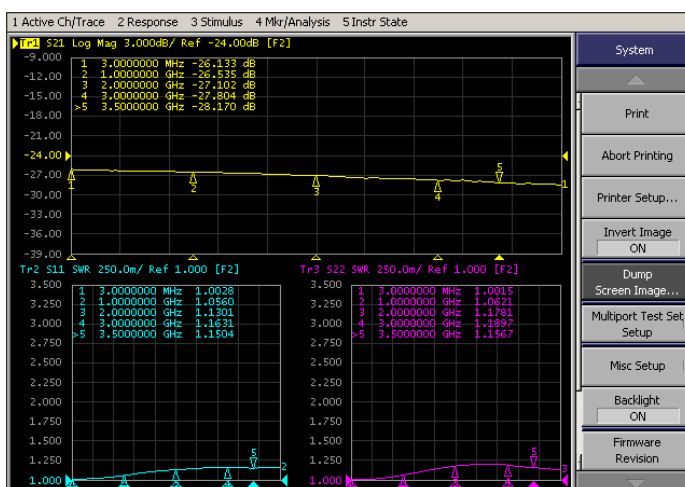

Model No. Description

VAS ** ** ** * * *
 Type Attenuation Range Step Value Connector Type Max. Power Connector Option

VAS: Step Variable Attenuator

Type: 06 represents type number

Attenuation Range: Maximum attenuation.

Connector Type: S and N available. S is SMA and N is N type connector.

Max. Power: 2 and 5 are available, currently 2W and 5W are available.

Connector Options:

Options	IO
1	Female/Female
2	Male/Female
3	Male/Male

Package Outlines

Connector Position: "A" represents back connectors, without "A" represents left and right connectors.

SMA Connector

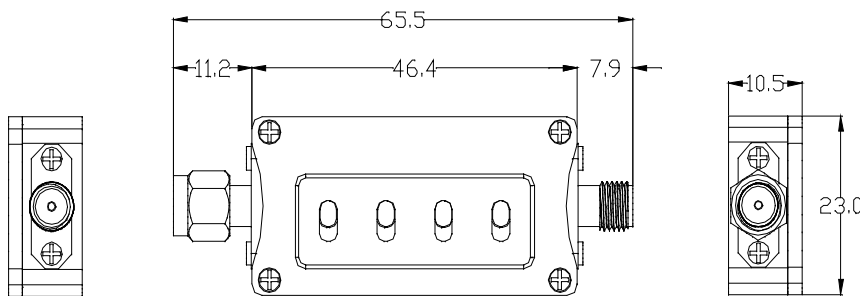

Package type: S22, Net weight: 24.3g

N-type Connector

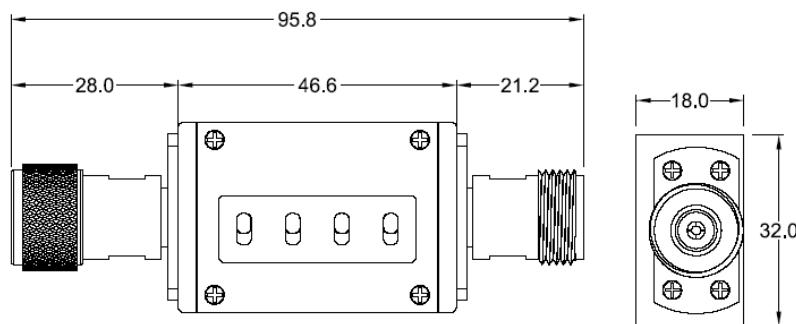

Package type: N22, Net weight: 78.8 g

NOTE:

1. ALL dimensions shown in mm(tolerance: +/-0.05mm) unless stated otherwise
2. RoHS Compliant in accordance with EU Directive(2011/65/EU)

Yantel Corporation

Add: 3F, Building 3, Southern District 2 of ZhongGuan Honghualing Industrial Park, Xili, Nanshan, Shenzhen, China
 Tel: 86-755-8355-1886 Fax: 86-755-8355-2533

Mounting Instructions: Unit(mm)

This product is panel-mountable via screws.

- Four mounting holes on the product plate. Refer to Fig2, Fig6.
- H represents the thickness of panel. Refer to Fig3, Fig4.
- Recommended length of the screw is 3mm+H. Refer to Fig5.

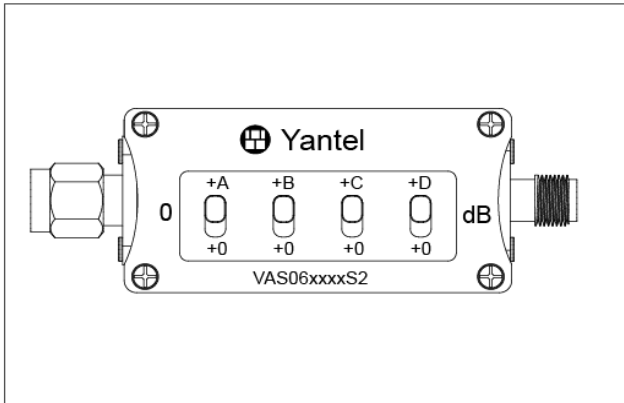

Front View Fig 2

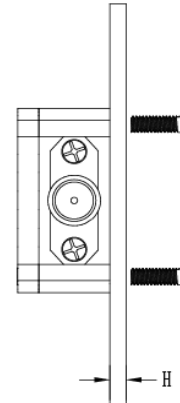

Lateral View Fig 3

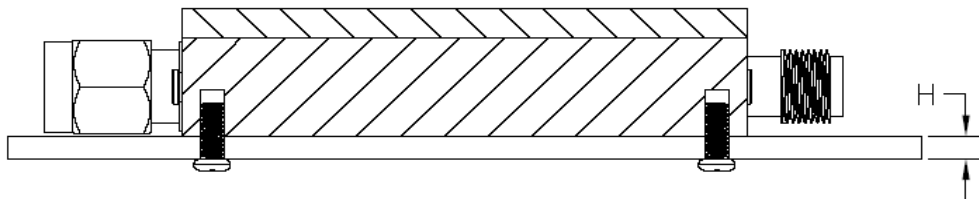

Sectional View Fig 4

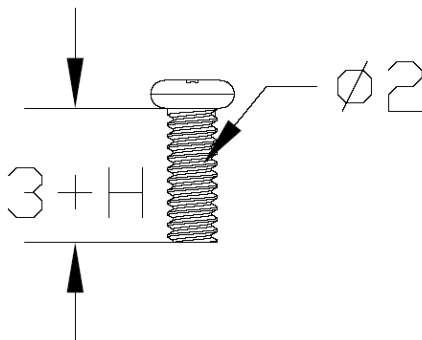

Recommended length of the screw Fig 5

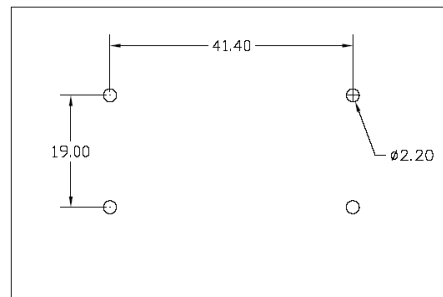

Mounting holes on user's panel Fig 6

Note:

Attempt to disassemble the product can damage it and void your warranty. In case of any malfunction, please contact your local representative, distributor or the factory immediately.