

Part No. Descriptions

Part No.	Frequency Range (GHz)	Attenuation (dB)	Temperature Coefficient Code	Temperature Coefficient of Attenuation (dB/dB/°C)	Max. VSWR (:1) @1GHz@25°C	Max. Input Power (mW)	Attenuation Accuracy (dB)
WTCA2002N*WB2	DC-20	2	N3~N7	-0.003~ -0.007	1.2	200	±0.5
WTCA2003N*WB2	DC-20	3	N3~N9	-0.003~ -0.009	1.2	200	±0.5
WTCA2004N*WB2	DC-20	4	N3~N9	-0.003~ -0.009	1.2	200	±0.5
WTCA2005N*WB2	DC-20	5	N3~N10	-0.003~ -0.010	1.2	200	±0.5
WTCA2006N*WB2	DC-20	6	N3~N10	-0.003~ -0.010	1.2	200	±0.5
WTCA2007N*WB2	DC-20	7	N3~N10	-0.003~ -0.010	1.2	200	±0.5

General Specifications

- | | |
|--|--|
| 1. Frequency Range | DC to 20GHz |
| 2. Attenuation | 4dB |
| 3. Attenuation Accuracy | at 25°C ±0.5dB@1GHz |
| 4. VSWR | at 25°C 1.35:1 Max. over DC-18GHz
1.50:1 Max. over 18-20GHz |
| 5. Nominal Impedance | 50 Ohms |
| 6. Power Rating | 200 mW CW |
| 7. Power Derating | 100% @ 125°C
Derates to 0% @ 150°C |
| 8. Operating Temperature | -55°C to +150°C |
| 9. Temperature Coefficient over Operating Temperature Range: See Table Above. | Temperature Coefficient Tolerance: ±0.001dB/dB/°C. |
| 10. Substrate: Alumina (Al ₂ O ₃) | |
| 11. Resistive material: Thick film | |
| 12. Terminal material: Thick film, Input, Output and front Ground all made by gold, Back Ground made by Pd/Ag. | |
| 13. Protective Coating: Thick film (ethyl acetate) | |
| 14. Package Outline: See Sheet 4. | |
| 15. Workmanship: per MIL-PRF-55342. | |
| 16. RoHS Compliant. | |
| 17. Electrostatic Discharge Control: per MIL-STD-1686. | |

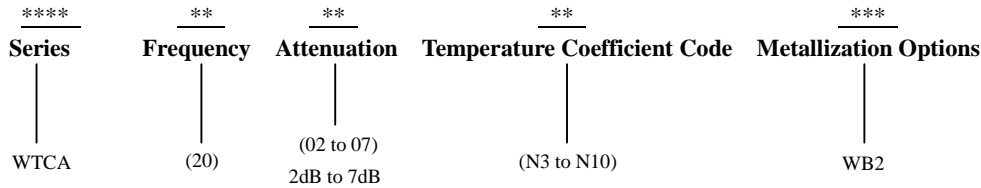
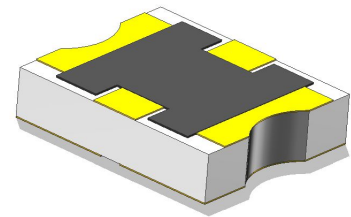

Unit Marking dB Value (XX), Direction of Shift (N) and TCA Shift (X).
Legibility and Permanency: per MIL-STD-130.

Quality Assurance

1. Sample inspect per ANSI/ASQC Z1.4 general inspection, LEVEL II, AQL = 1.0.
 - 1.1 Visual and mechanical examination for conformance to outline package requirements.
2. Select five (5) Units from lot measure attenuation from DC to 20GHz every 20°C over the temperature range -55°C to +125°C.
 - 2.1 Calculate, using linear regression, the slope of the curve.
 - 2.2 Calculate TCA using the following formula: TCA = Slope / Attenuation @ 25°C.
3. Test data required for customer.

WTCA Response

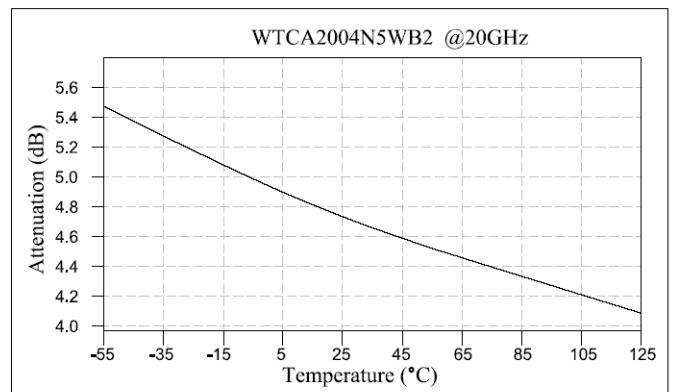
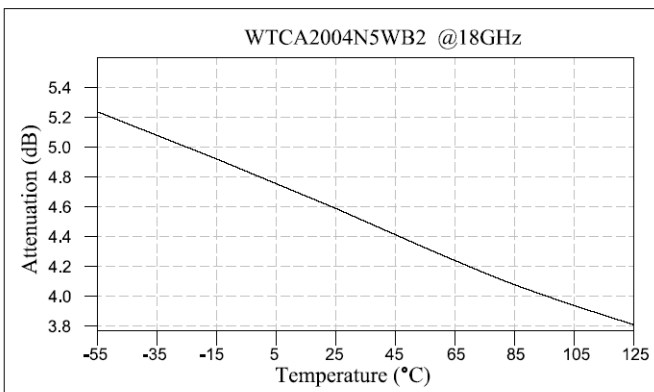
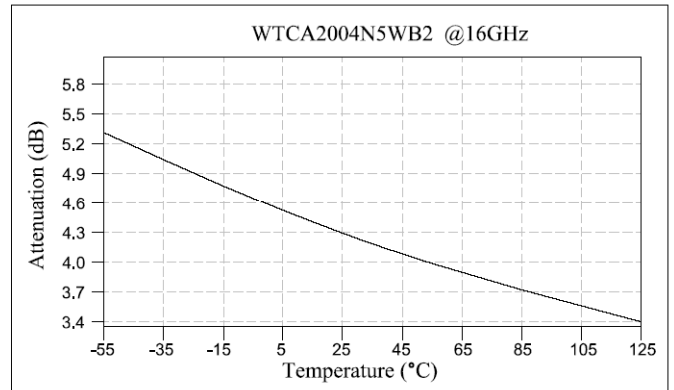
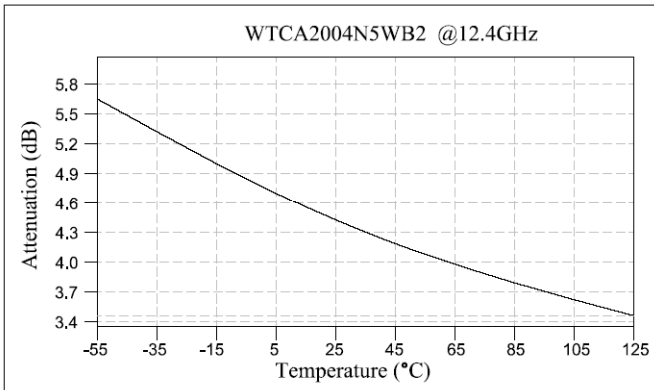
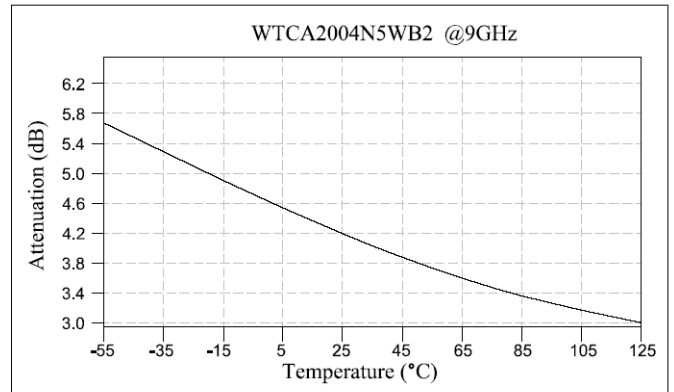
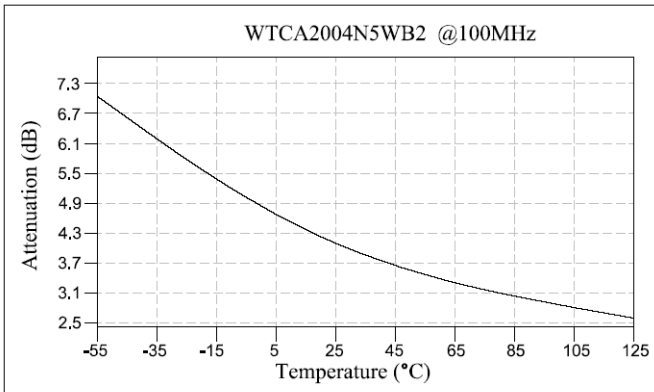

Typical VSWR @25°C



Power Rating & Derating Curve

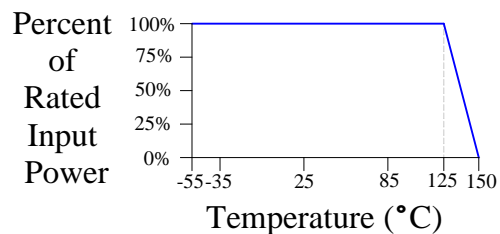

Notes on RF Testing and Circuit Layout

DC-20GHz WB2 series(for Gold Terminal type) Test Fixture

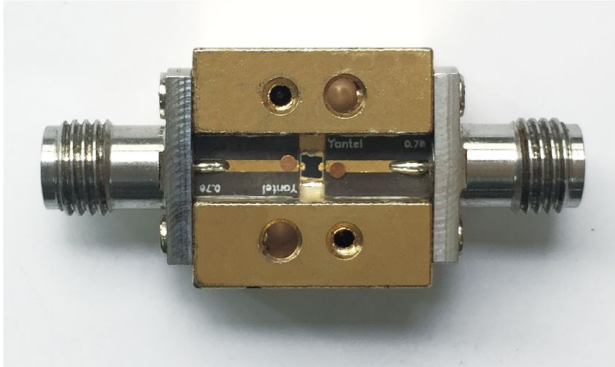

WB2 PCB Test Board

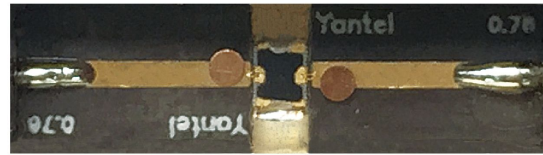

Connect test part to Test Fixture

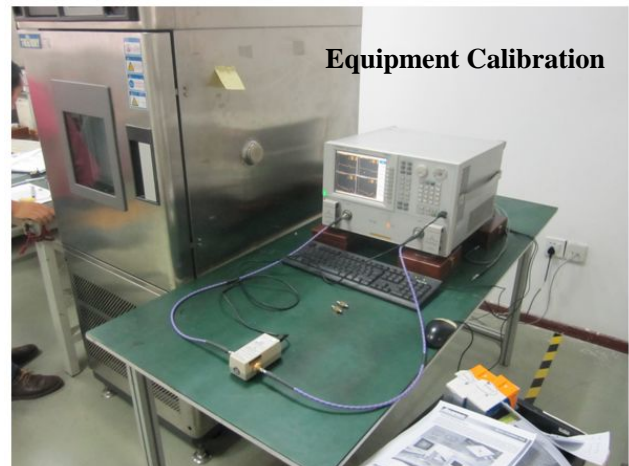
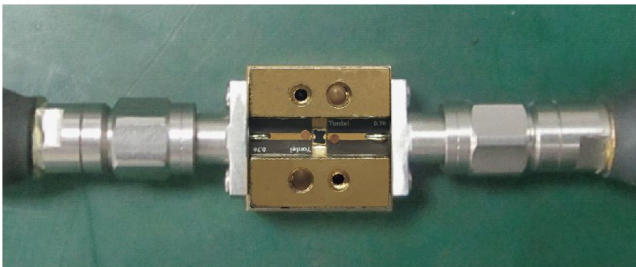

Equipment Calibration

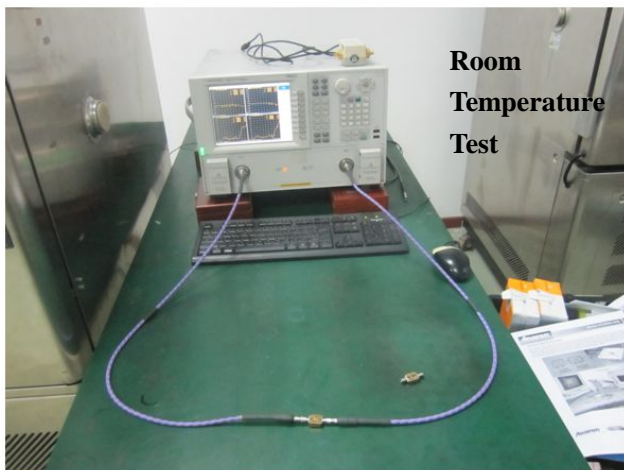

Room Temperature Test



High-Low Temperature Test

- 1、 S2P documents are available for download
- 2、 DC-20GHz or 16-36GHz test fixture is rentable (only for Chinese customers) , otherwise please purchase them.

For any questions or needs, please feel free to contact inform@yantel-corp.com.

Yantel Corporation

Add: 3F, Building 3, Southern District 2 of Zhongguan Honghualing Industrial Park, Xili, Nanshan, Shenzhen, China

Tel: 86-755-8355-1886 Fax: 86-755-8355-2533

For detailed performance specs & shopping online see Yantel web site : www.yantel-corp.com

Package Outlines

All dimensions shown in mm unless stated otherwise
 Note: Dimension tolerance in ± 0.10 otherwise mention.

Unit: mm

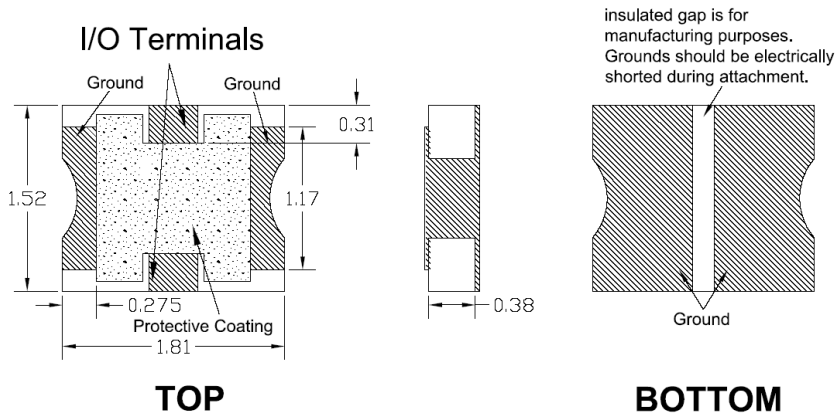

Tape & Reel Drawing

All dimensions shown in mm unless stated otherwise

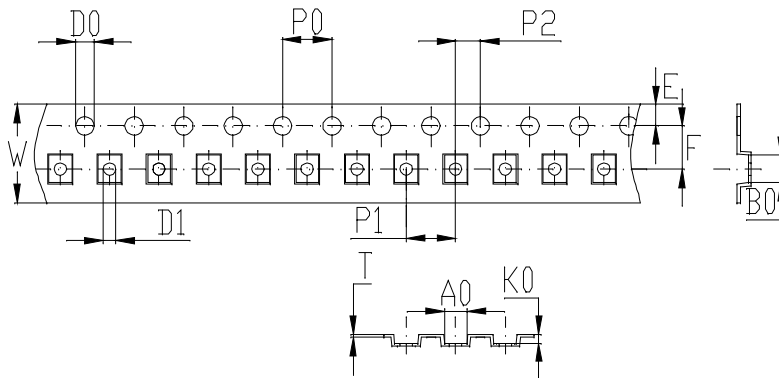

Notice:

- A.10 Sprocket hole pitch cumulative tolerance is 0.2mm.
- B. Carrier camber shall be not more than 1mm per 100mm through a length of 250mm.
- C. All dimensions meet EIA-418-B requirements.
- D. A0 & B0 measured as indicated.
- E. K0 measured from a place on the inside bottom of the pocket to top surface of carrier.
- F. Material: PS
- G. Thickness: 0.25 ± 0.05 mm
- H. 3000 units (maximum) / T&R

symbol	A0	B0	K0	P0	P1	P2
spec	1.85 ± 0.1	2.25 ± 0.1	0.7 ± 0.1	4.0 ± 0.1	4.0 ± 0.1	2.0 ± 0.1
symbol	W	T	E	F	D0	D1
spec	8.0 ± 0.3	0.25 ± 0.05	1.75 ± 0.1	3.5 ± 0.1	$\Phi 1.5^{+0.1}_{-0.0}$	$\Phi 1.0^{+0.1}_{-0.0}$

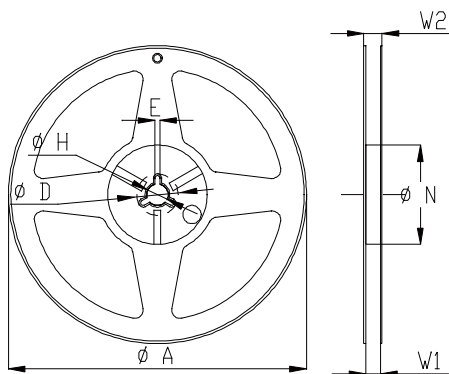

Symbol	Dimensions(mm)
A	$180^{+0/-3}$
N	$60^{+1/-0}$
W1	9.0 ± 0.3
W2	11 ± 1.0
D	25 ± 0.8
H	13 ± 0.2
E	3 ± 0.5

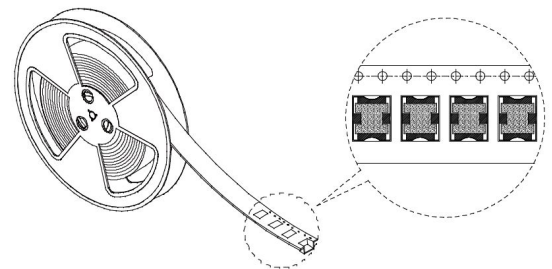

Yantel Corporation

Add: 3F, Building 3, Southern District 2 of Zhongguan Honghualing Industrial Park, Xili, Nanshan, Shenzhen, China
 Tel: 86-755-8355-1886 Fax: 86-755-8355-2533

For detailed performance specs & shopping online see Yantel web site : www.yantel-corp.com