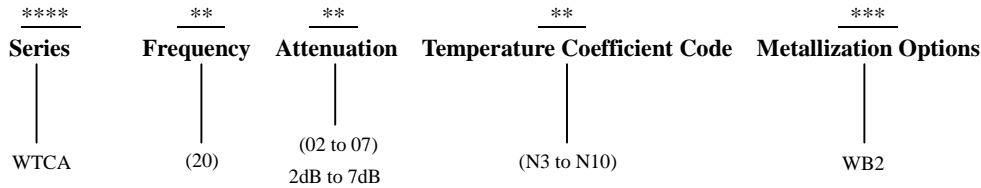
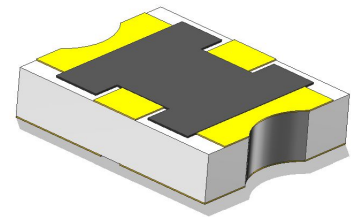

**Part No. Descriptions**

Part No.	Frequency Range (GHz)	Attenuation (dB)	Temperature Coefficient Code	Temperature Coefficient of Attenuation (dB/dB/°C)	Max. VSWR (:1) @1GHz@25°C	Max. Input Power (mW)	Attenuation Accuracy (dB)
WTCA2002N*WB2	DC-20	2	N3~N7	-0.003~ -0.007	1.2	200	±0.5
WTCA2003N*WB2	DC-20	3	N3~N9	-0.003~ -0.009	1.2	200	±0.5
WTCA2004N*WB2	DC-20	4	N3~N9	-0.003~ -0.009	1.2	200	±0.5
WTCA2005N*WB2	DC-20	5	N3~N10	-0.003~ -0.010	1.2	200	±0.5
WTCA2006N*WB2	DC-20	6	N3~N10	-0.003~ -0.010	1.2	200	±0.5
WTCA2007N*WB2	DC-20	7	N3~N10	-0.003~ -0.010	1.2	200	±0.5

**General Specifications**

- |  |   |
|--|---|
| <ol style="list-style-type: none"> <li>1. Frequency Range</li> <li>2. Attenuation</li> <li>3. Attenuation Accuracy</li> <li>4. VSWR</li> <li>5. Nominal Impedance</li> <li>6. Power Rating</li> <li>7. Power Derating</li> <li>8. Operating Temperature</li> <li>9. Temperature Coefficient over Operating Temperature Range: See Table Above.</li> <li>10. Substrate: Alumina (Al<sub>2</sub>O<sub>3</sub>)</li> <li>11. Resistive material: Thick film</li> <li>12. Terminal material: Thick film, Input, Output and front Ground all made by gold, Back Ground made by Pd/Ag.</li> <li>13. Protective Coating: Thick film (ethyl acetate)</li> <li>14. Package Outline: See Sheet 4.</li> <li>15. Workmanship: per MIL-PRF-55342.</li> <li>16. RoHS Compliant.</li> <li>17. Electrostatic Discharge Control: per MIL-STD-1686.</li> </ol> | <p>DC to 20GHz</p> <p>7dB</p> <p>at 25°C ±0.5dB@1GHz</p> <p>at 25°C 1.45:1 Max. over DC-20GHz</p> <p>50 Ohms</p> <p>200 mW CW</p> <p>100% @ 125°C</p> <p>Derates to 0% @ 150°C</p> <p>-55°C to +150°C</p> <p>Temperature Coefficient Tolerance: ±0.001dB/dB/°C.</p> |
|--|---|

**Unit Marking**

dB Value (XX), Direction of Shift (N) and TCA Shift (X).  
 Legibility and Permanency: per MIL-STD-130.

**Quality Assurance**

1. Sample inspect per ANSI/ASQC Z1.4 general inspection, LEVEL II, AQL = 1.0.
  - 1.1 Visual and mechanical examination for conformance to outline package requirements.
2. Select five (5) Units from lot measure attenuation from DC to 20GHz every 20°C over the temperature range -55°C to +125°C.
  - 2.1 Calculate, using linear regression, the slope of the curve.
  - 2.2 Calculate TCA using the following formula: TCA = Slope / Attenuation @ 25°C.
3. Test data required for customer.

**Yantel Corporation**

Add: 3F, Building 3, Southern District 2 of Zhongguan Honghualing Industrial Park, Xili, Nanshan, Shenzhen, China  
 Tel: 86-755-8355-1886 Fax: 86-755-8355-2533

For detailed performance specs & shopping online see Yantel web site : [www.yantel-corp.com](http://www.yantel-corp.com)

**WTCA Response**

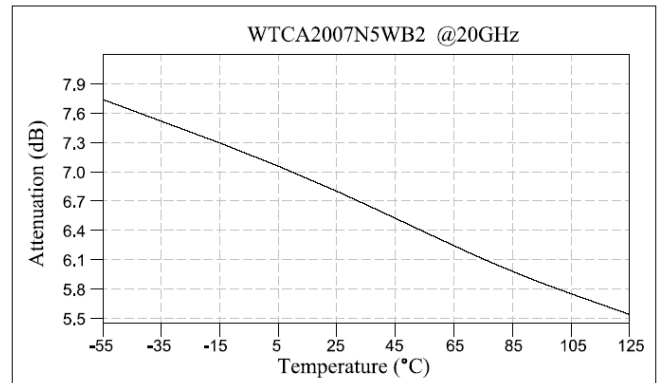
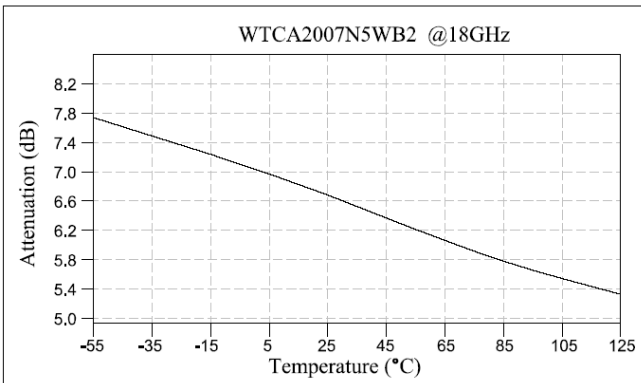
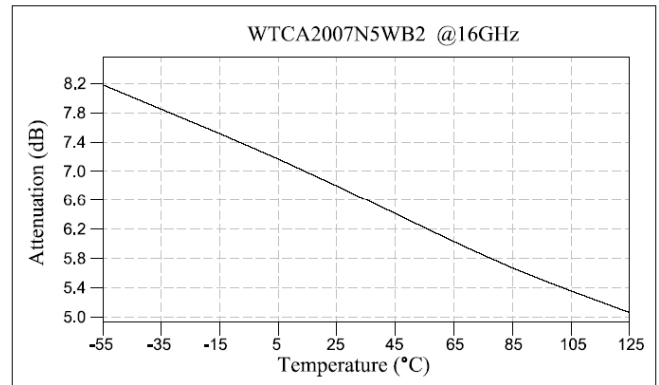
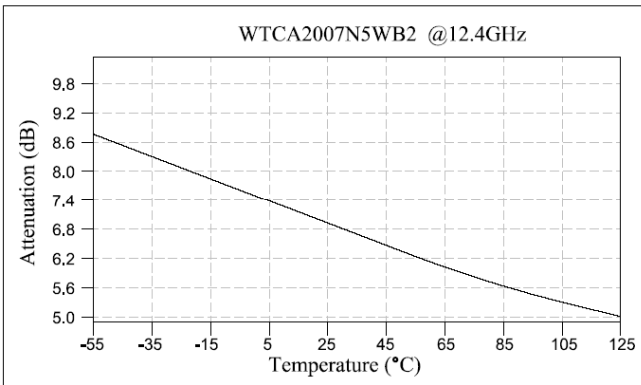
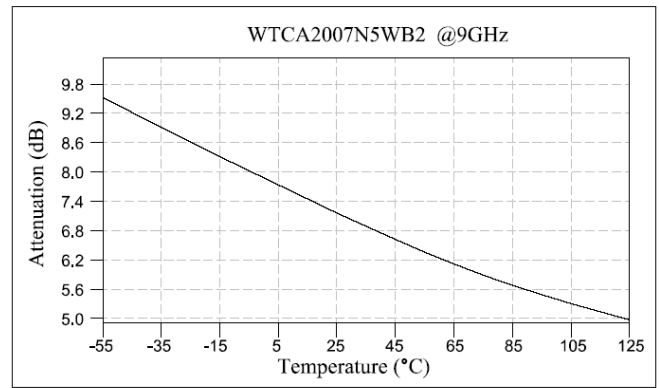
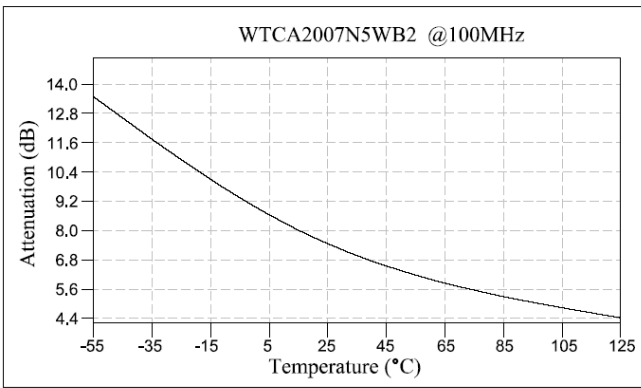

**Typical VSWR @25°C**



**Power Rating & Derating Curve**

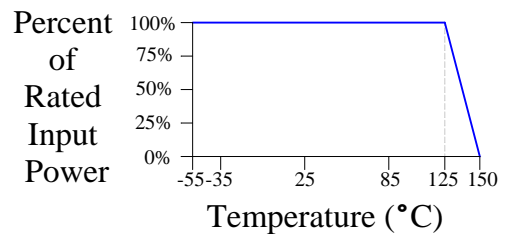

**Notes on RF Testing and Circuit Layout**

**DC-20GHz WB2 series(for Gold Terminal type) Test Fixture**

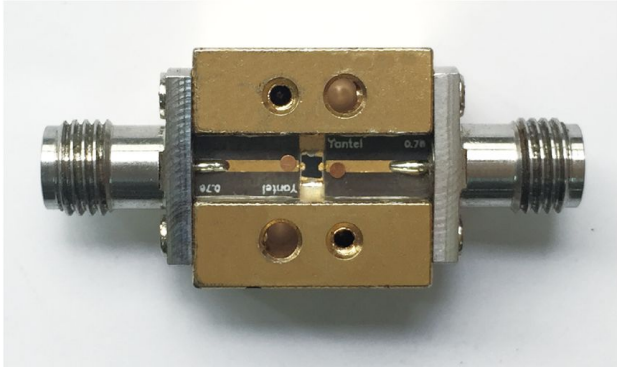

**WB2 PCB Test Board**

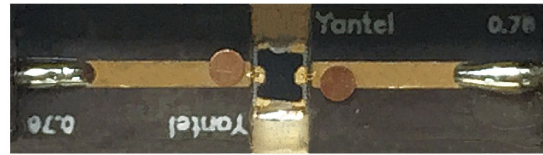

**Connect test part to Test Fixture**

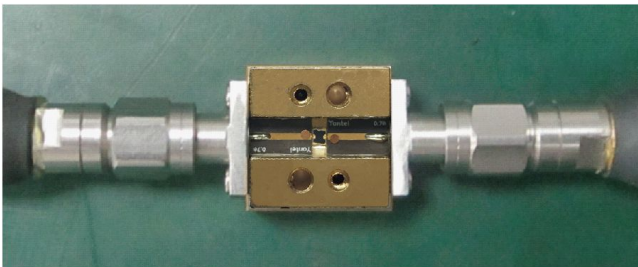

**Equipment Calibration**

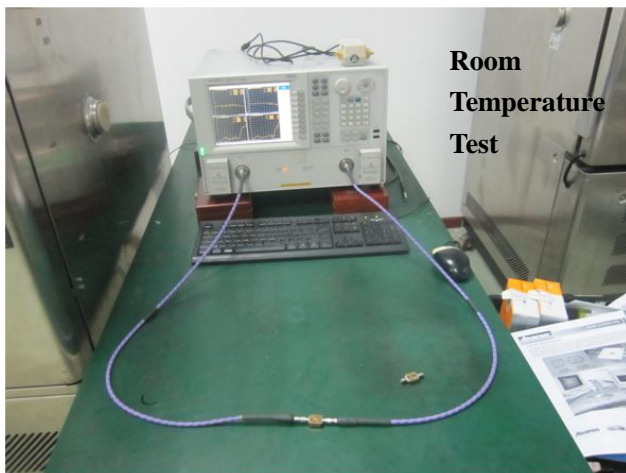

**Room Temperature Test**

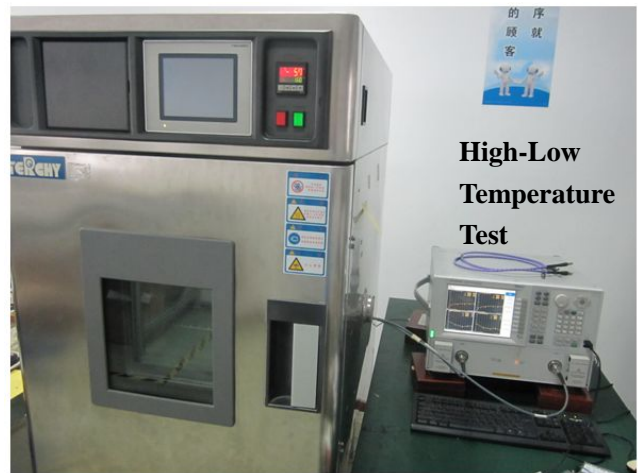

**High-Low Temperature Test**

- 1、 S2P documents are available for download
- 2、 DC-20GHz or 16-36GHz test fixture is rentable (only for Chinese customers) , otherwise please purchase them.

For any questions or needs, please feel free to contact [inform@yantel-corp.com](mailto:inform@yantel-corp.com).

### Package Outlines

All dimensions shown in mm unless stated otherwise

Unit: mm

Note: Dimension tolerance in  $\pm 0.10$  otherwise mention.

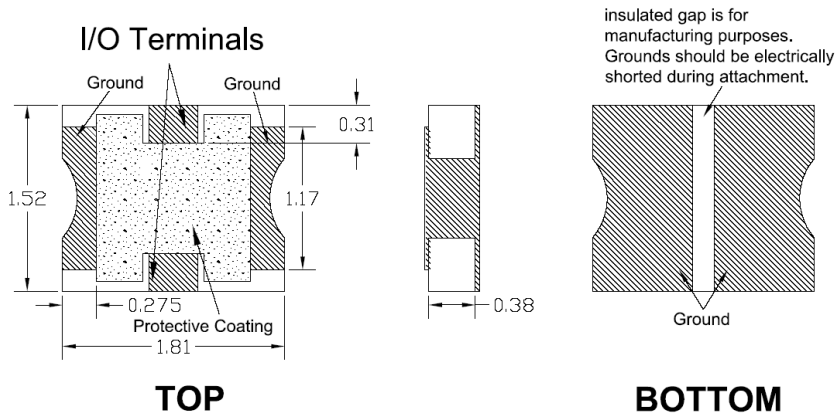

### Tape & Reel Drawing

All dimensions shown in mm unless stated otherwise

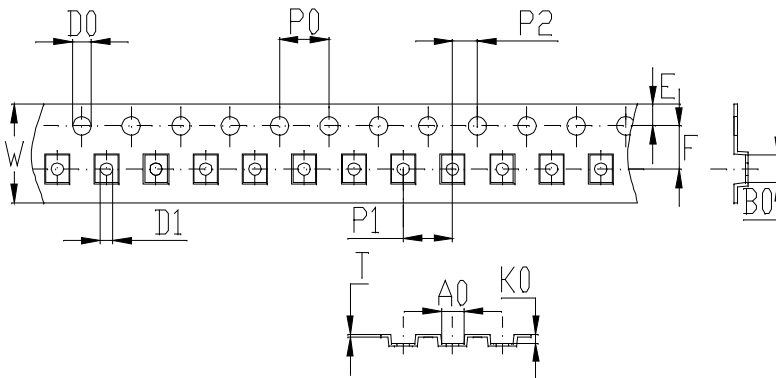

Notice:

- A.10 Sprocket hole pitch cumulative tolerance is 0.2mm.
- B. Carrier camber shall be not more than 1mm per 100mm through a length of 250mm.
- C. All dimensions meet EIA-418-B requirements.
- D. A0 & B0 measured as indicated.
- E. K0 measured from a place on the inside bottom of the pocket to top surface of carrier.
- F. Material: PS
- G. Thickness:  $0.25 \pm 0.05$ mm
- H. 3000 units (maximum) / T&R

symbol	A0	B0	K0	P0	P1	P2
spec	$1.85 \pm 0.1$	$2.25 \pm 0.1$	$0.7 \pm 0.1$	$4.0 \pm 0.1$	$4.0 \pm 0.1$	$2.0 \pm 0.1$
symbol	W	T	E	F	D0	D1
spec	$8.0 \pm 0.3$	$0.25 \pm 0.05$	$1.75 \pm 0.1$	$3.5 \pm 0.1$	$\Phi 1.5^{+0.1}_{-0.0}$	$\Phi 1.0^{+0.1}_{-0.0}$

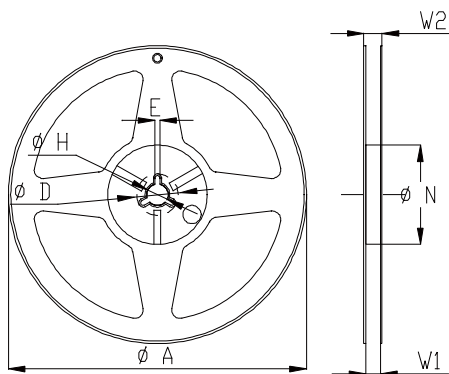

Symbol	Dimensions(mm)
A	$180^{+0/-3}$
N	$60^{+1/-0}$
W1	$9.0 \pm 0.3$
W2	$11 \pm 1.0$
D	$25 \pm 0.8$
H	$13 \pm 0.2$
E	$3 \pm 0.5$

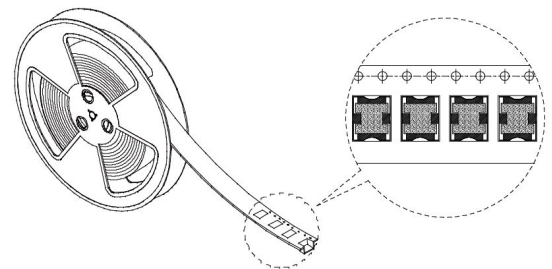

### Yantel Corporation

Add: 3F, Building 3, Southern District 2 of Zhongguan Honghualing Industrial Park, Xili, Nanshan, Shenzhen, China

Tel: 86-755-8355-1886 Fax: 86-755-8355-2533

For detailed performance specs & shopping online see Yantel web site : [www.yantel-corp.com](http://www.yantel-corp.com)