

Description

Yantel's surface mount catalog bandpass filters utilize Yantel's low loss temperature stable materials which offer small size and minimal performance variation over temperature. The catalog BPF's are offered in a variety of frequency bands, which offers a drop in solution with highly repeatable performance.

Features

- Small Size
- Fully Shielded Component
- Solder Surface Mount Package
- Moisture Sensitivity Level: MSL1
- Frequency Stable over Temperature
- Operating & Storage Temp: -55°C to +125°C
- Characteristic Impedance: 50Ω

Specifications*

Parameter	Frequency Range (GHz)	Min	Typ.	Max
Insertion Loss (dB)	3.78 - 4.22		2.5	2.75
Return Loss (dB)			12.0	15.0
Low Side Rejection (dB)	DC - 3.4		40.0	50.0
High Side Rejection (dB)	4.6 - 10.0		40.0	45.0
CW Input Power** (W)				10
$\theta_{jc} \left(\frac{^{\circ}\text{C}}{\text{W}} \right)$	7.5			
Size (L x W x H)	0.500 x 0.250 x 0.103 in 12.7 x 6.35 x 2.62 mm			

*Electrical specifications based on typical probed performance at room temperature. Insertion loss shall vary ± 0.5 dB over temperature.

**Power rating assumes the component will be mounted to a PCB with good thermally conducting ground vias as outlined in the recommended PCB layout that are connected to an adequate heat sink. Max power is based on 125°C base temperature.

Typical Measured Performance

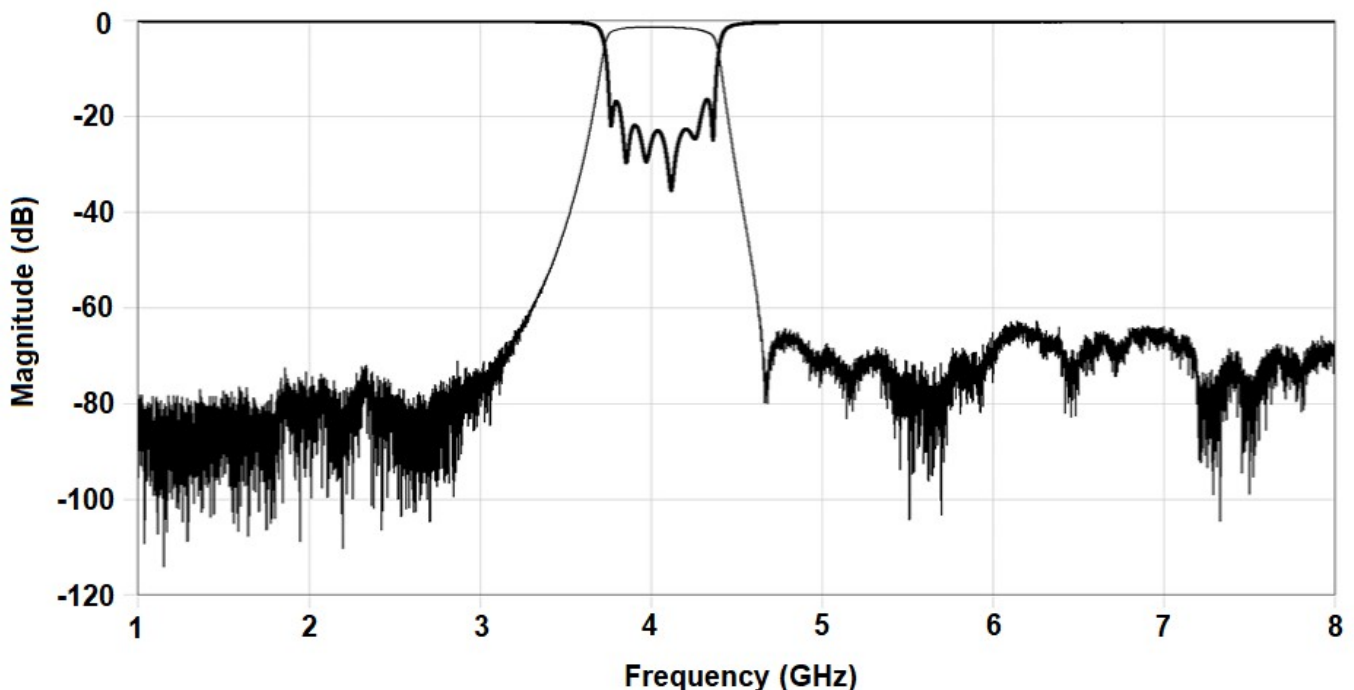

*Typical de-embedded measured performance mounted on a connectorized test fixture. DEB is 0.254mm RO4350B with 50.00ohm CPW ground traces going into the ports at room temperature.

Yantel Corporation

Add: No.308-322,3F,Building 1,Juchuang Jingu Innovation Park,Wenyuan Road 35,Xili Street,Nanshan,Shenzhen,China

Tel: 86-755-8355-1886 Fax: 86-755-8355-2533

For detailed performance specs & shopping online see Yantel web site : www.yantel-corp.com

Physical Dimensions

Units = inches

Top View

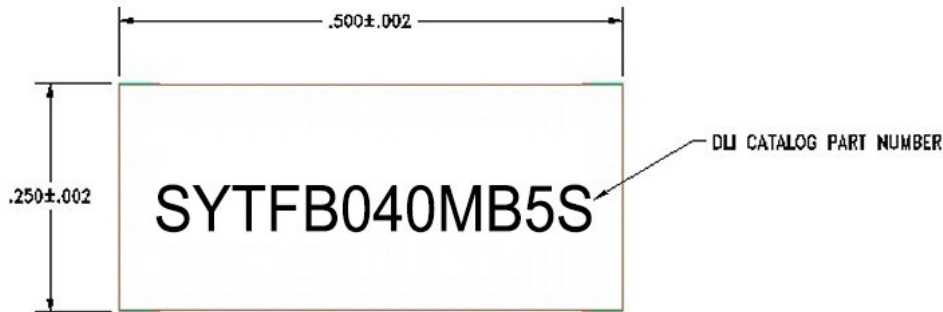

Side View

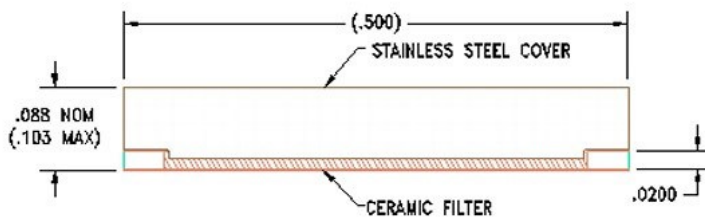

End View

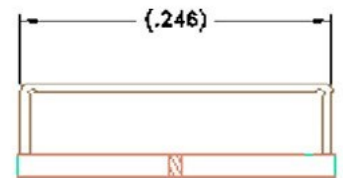

Bottom View

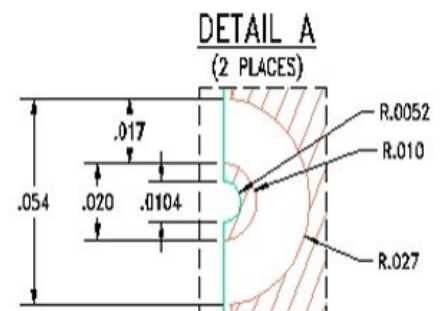
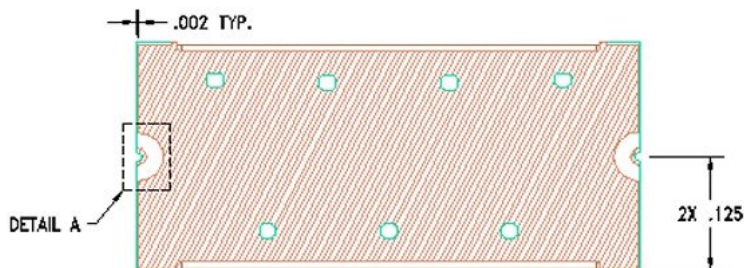

Notes :

- Termination Finish:
ENIG: 3 - 6 μinch Au over 50 μinch Ni
- Maximum Assembly Process Temperature: 250°C

Tolerances:

For values with 3 decimal places ± 0.001

For values with 4 decimal places ± 0.0005

Recommended PCB Layout

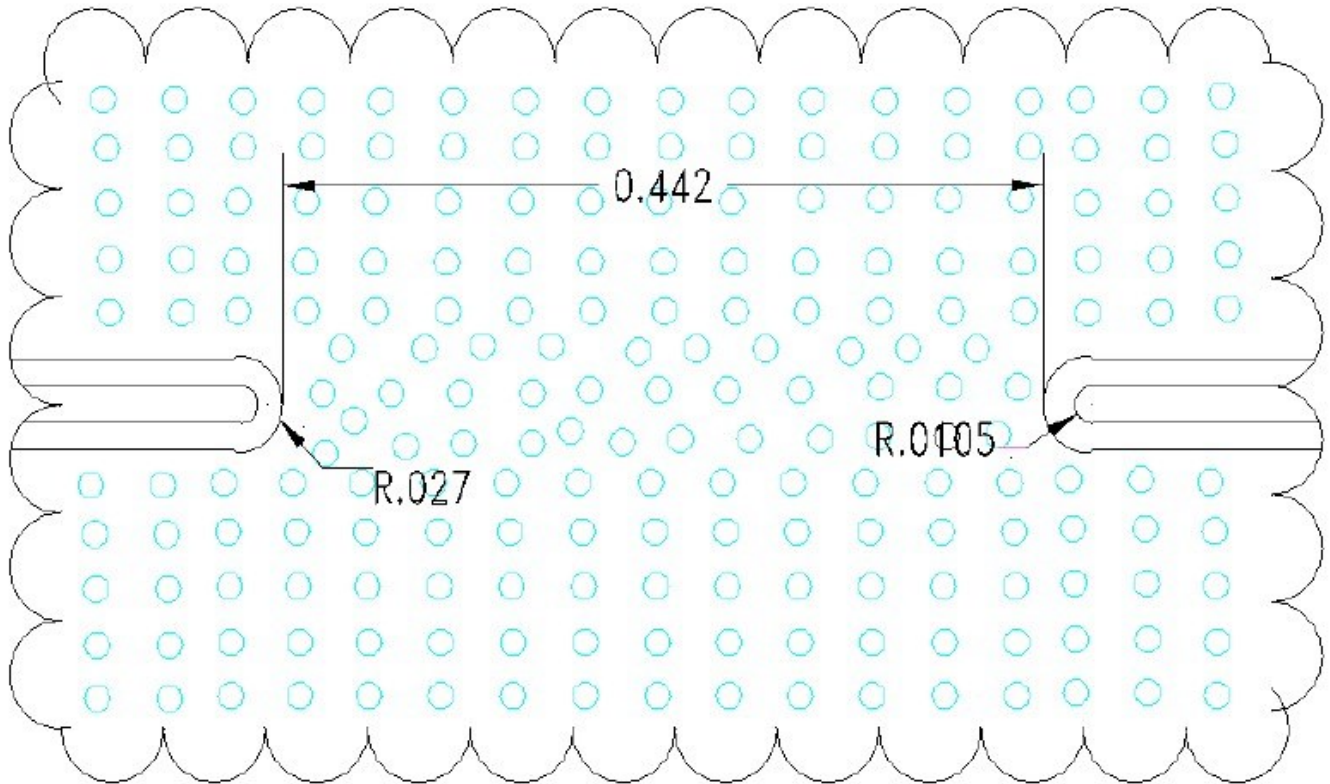

Units = inches

Note:

- 50Ω trace dimensions are application specific.
- Ensure adequate grounding beneath the part.